



Larry Jump
Viavi Solutions
SCTE February 2017
814 692 4294
larry.jump@viavisolutions.com

Equalizers and their use in Preventative Network Maintenance

Objectives

- To better understand equalizers and how they can be interpreted.
- To understand the difference between equalizers and pre-equalizers.
- To understand the Preventative Network Maintenance, (PNM) program developed by CableLabs
- To understand how the EQ function in a meter can be used to aid in localizing problems when troubleshooting.

Agenda

- Terms
- Adaptive Equalization
- Pre Equalization
- PNM Process
- Troubleshooting

Impedance

- In transmission line theory it is understood that in order to get maximum power transfer from the source to the load, a constant impedance must be maintained. (75 ohms)
- HFC systems strive to maintain this impedance.
- If there is **any** impedance mismatch, some of the transmitted signal is reflected back to the source.
 - <http://techchannel.att.com/play-video.cfm/2011/3/7/AT&T-Archives-Similarities-of-Wave-Behavior>

Impedance and Reflections

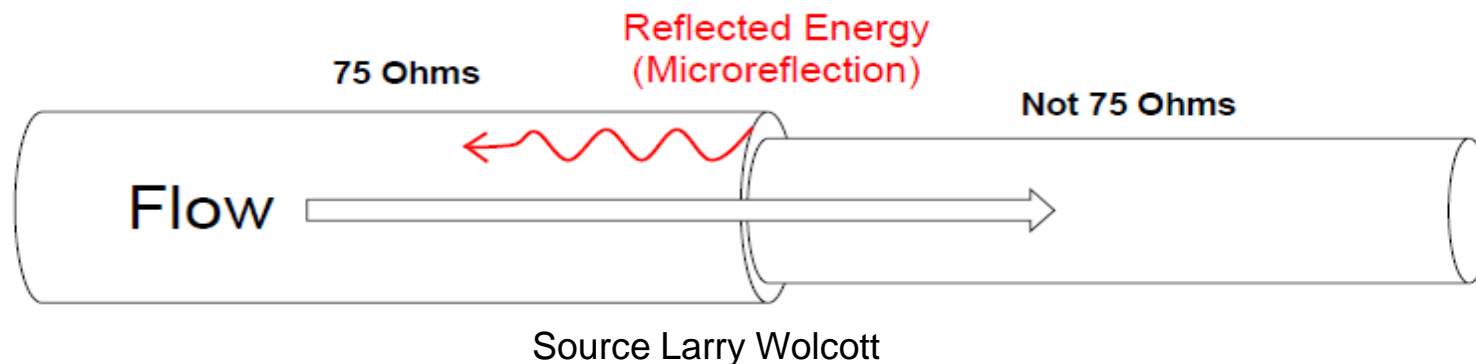

- Transmitted signal arrives at the impedance mismatch and some of the energy is reflected back toward the source.
- We can measure the amplitude of the reflected energy.
- We can measure the amount of time it takes for the reflected energy to arrive back at the source.
- Since we know how fast signals travel through the cable, we can calculate the *approximate* distance to the fault.

Micro-reflections

- Micro-reflections are caused by impedance mismatches
- In the real world of cable networks, 75 Ω impedance is at best considered nominal
- Micro-reflections cause group delay and frequency response problems.
- Impedance mismatches are everywhere: connectors, amplifiers inputs and outputs, passive device inputs and outputs, and even the cable itself
- Upstream cable attenuation is lower than downstream cable attenuation, so micro-reflections tend to have more of an affect on the upstream.

Sources of Micro reflections that cause Linear Distortions

- Diplex and Band Pass Filters
- Bad cable terminations including tap ports and TV Receivers
- Damaged Cable
- Signal Combiners
- Poor Connectors
- Any Impedance Mismatch!

Coax Impedance Factors

- What affects the impedance of coaxial cable?
 - The inner diameter of the outer conductor
 - The outer diameter of the inner conductor
 - The dielectric constant (keeps the distance constant between the center conductor and the outer conductor)

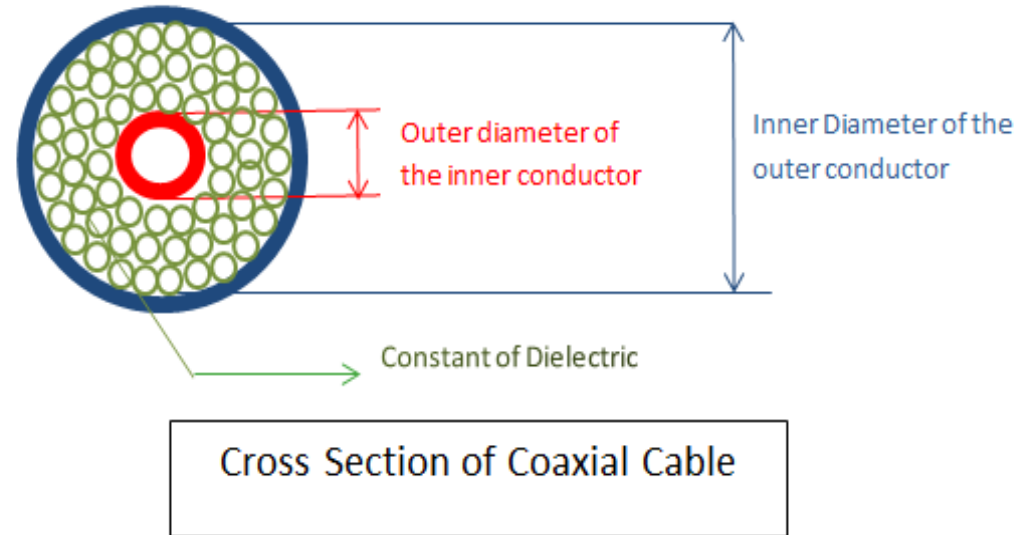

Return Loss

- RL is the difference in dB between the transmitted signal and the reflected signal at the worst case frequency.
- Modern coaxial cable manufacturers do an excellent job of maintaining characteristic impedance.
- Coaxial cable has a 28 dB RL or better
 - A 20 dB RL means that 10 % of the transmitted signal is reflected
 - A 16 dB RL means that 16% of the transmitted signal is reflected.
 - Typical RL specifications for input and output ports on amplifiers are 14 dB or about 20% signal is reflected.
 - **This makes them an significant source of reflections**

Velocity of Propagation

- Simply stated, this is how fast RF signals travel in a medium in relation to the speed of light in a vacuum.
- The speed of light in a vacuum = 186,000 miles / Sec or 982,080,000 ft./ sec. This equates to about 1.016nSecs / foot.
- For example, if a cable has a VoP of 87, that means that RF travels through the cable at 87% of the speed of light.
- It is dependent on the dielectric material of the cable so each different type of cable has a different VoP. As a note, water soaked dielectric can change the VoP of a coaxial cable.
- It is usually shown on the datasheet for the cable along with the losses. Some examples of VoP are: RG6 is 85, PIII is 87, and MC² is 93.

Adaptive Equalization

Spectrum Analyzers are still the first line of defense, but.....

Adaptive Equalizers, What are they and what do they do?

- Conditions the RF input signal before demodulation in a digital receiver
- Present in all digital receivers including CMTSSs, Cable Modems, STBs, and Test Equipment.
- The more taps, the better the AE is able to condition the incoming signal
- They affect only for the channel being received, not the entire frequency band
- They automatically and dynamically compensate for linear distortions caused by reflections that include:
 - Group Delay due to amplifier cascade and duplex filter roll-off
 - Amplitude Response
- They cannot compensate for noise and ingress

Other Advantages of Adaptive Equalizers

- They are used to analyze incoming signals
- Linear distortions can be viewed directly in real time
- No need for additional test signals
- AEs provide visibility into plant problems and location of problems that don't show up with typical spectrum analysis
- Amplitude response and group delay can be measured simultaneously and without service interruption.

Equalization

- At the RF Input, the signal is split and one side is passed through the adaptive EQ. This is the Main Tap
- In the other direction, the signal is passed through a delay, (Z) that equates to the approximate time it takes for the signal to be transmitted and reflected back.
- This time equates to distance as the Velocity of Propagation is known
- The amplifier amplifies the reflected signal and changes it to be 180° out of phase.
- The out of phase reflected signal is then combined with the transmitted signal with the original reflection effectively canceling it out.

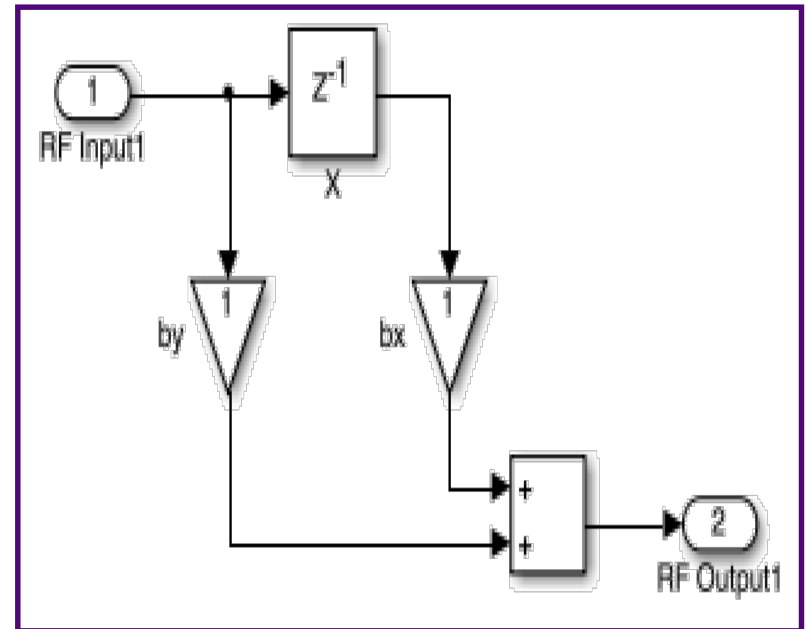

24-tap Equalizer

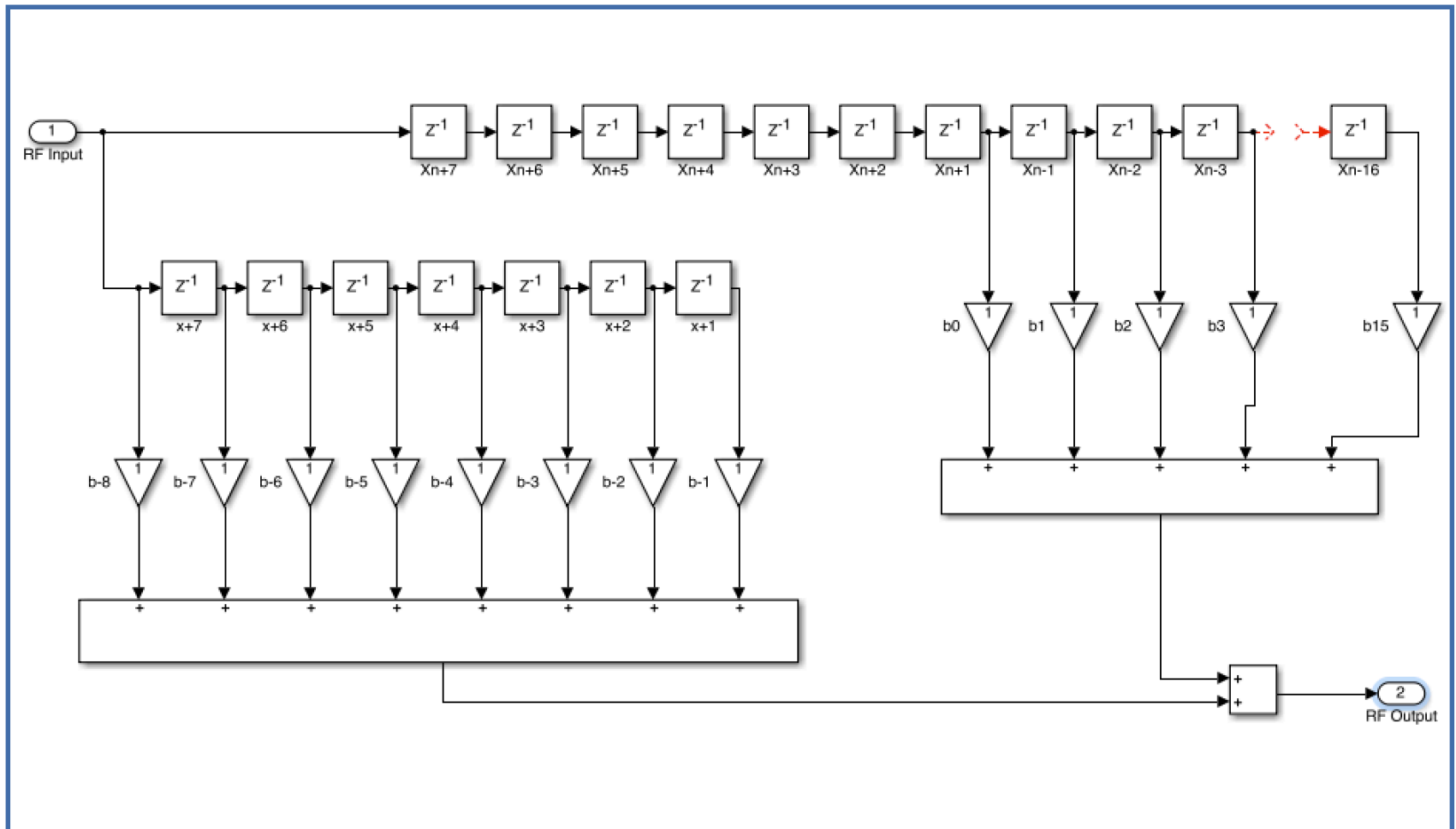

Adaptive Equalizers and Microreflections

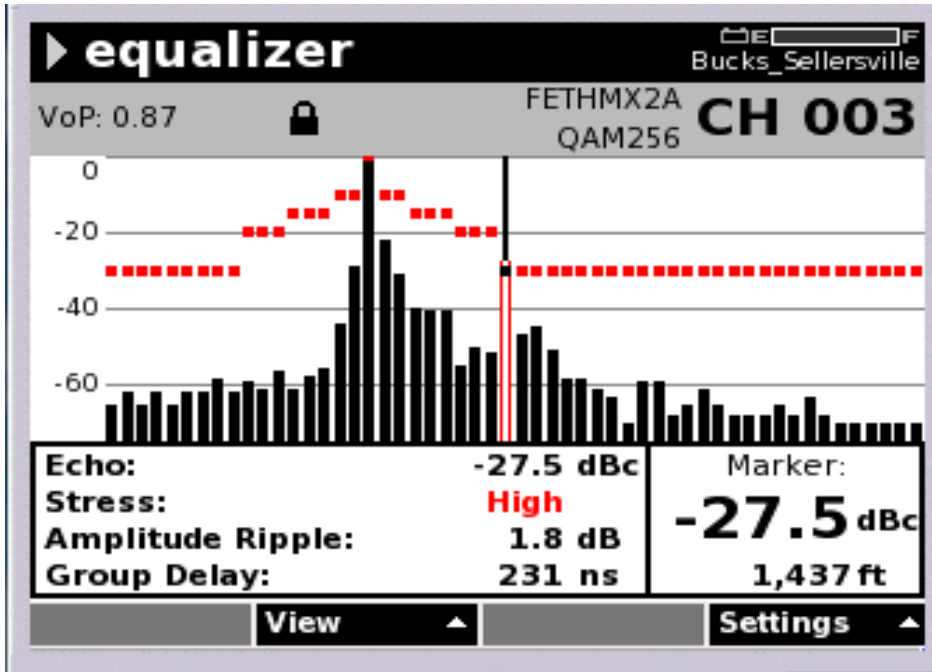

- Approximation of channel impulse response
- Red dots indicate Microreflection Threshold for each bar (DOCSIS Spec – Headroom)
- Any bar violating threshold is colored red
 - **Note:** Bar that violates threshold may not be the tallest bar (note stepdown of thresholds)
- Main Tap (time = zero) will always be the largest, will always be green

- X-Axis: Time bin in nS relative to main tap
- Y-Axis: Amplitude of signal relative to the carrier (dBc)
- Interpretation:
 - The farther the bar is to the right, the later the reflection arrived at the headend
 - The higher the level of a bar, the stronger the microreflection as received at the headend
- Common Causes:
 - Damaged/missing terminators, loose seizure screws, water-filled taps, cheap/damaged splitters or CPE, kinked/damaged cable, install Issues

Using The Cable Modem AE: Time distance calculations

Taps closest to the main tap indicate issues to the current measurement point

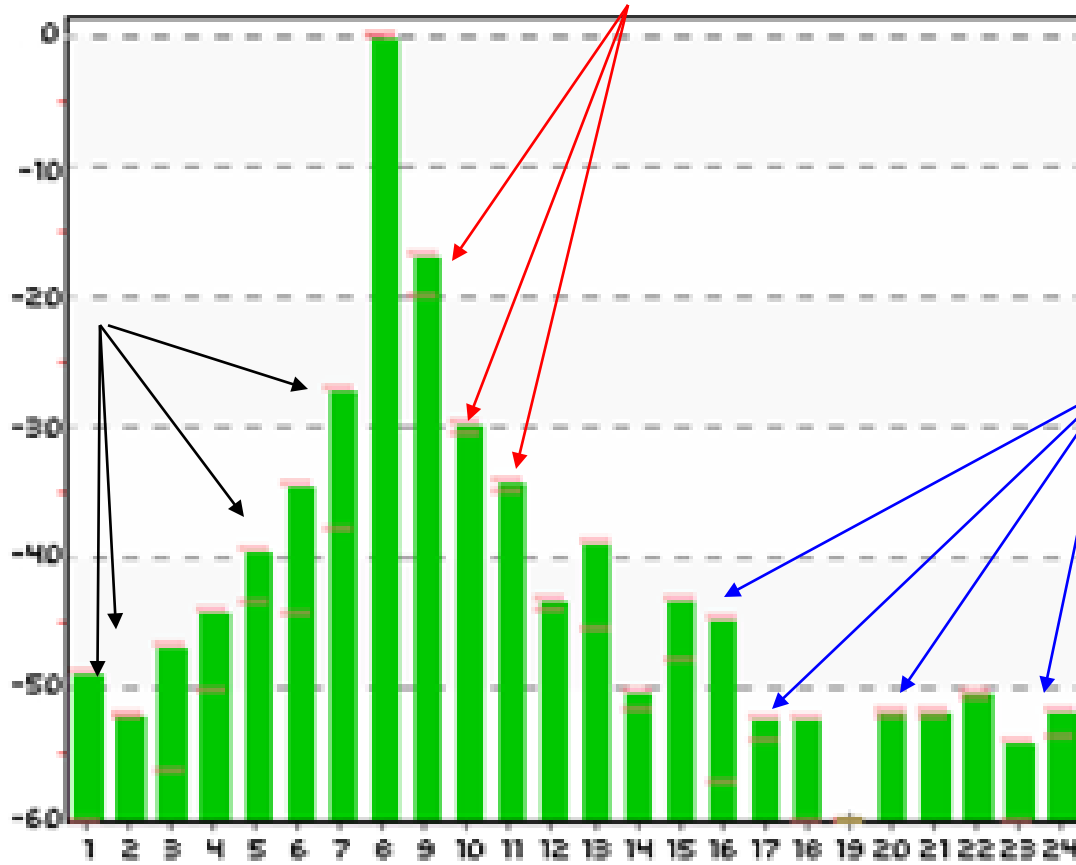

Taps to the left of the incident bit are an indicator of group delay issues

Taps farther away from the incident bit indicate issues further away in the HFC plant

Adaptive Equalizers and In-band Response

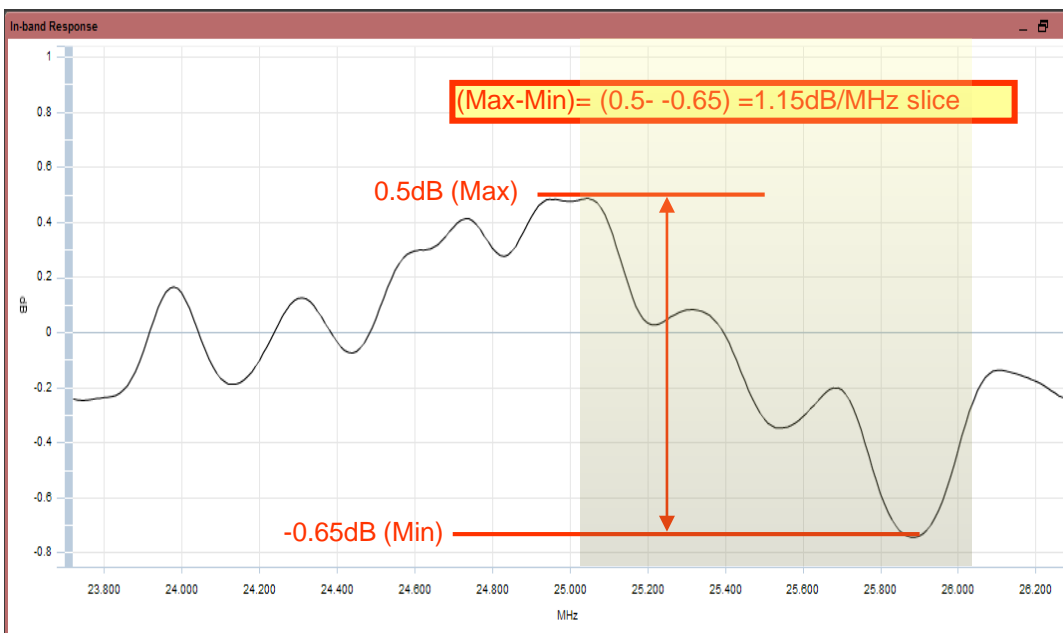

- Frequency response chart across a given carrier's frequency
- Think of it like a sweep display for the discrete carrier frequency range

- X-Axis: Frequency (covers frequency range of the carrier)
- Y-Axis: Amplitude of signal at each frequency relative to the average carrier level
- Interpretation:
 - A carrier with an ideal frequency response will have a flat response chart
 - Modems with very similar in-band response footprints may be impacted by a common impairment
 - Same water-filled tap, etc
- If we look at the response of the filter and then take the inverse, we have the In channel response.

Impairment Charts – Group Delay

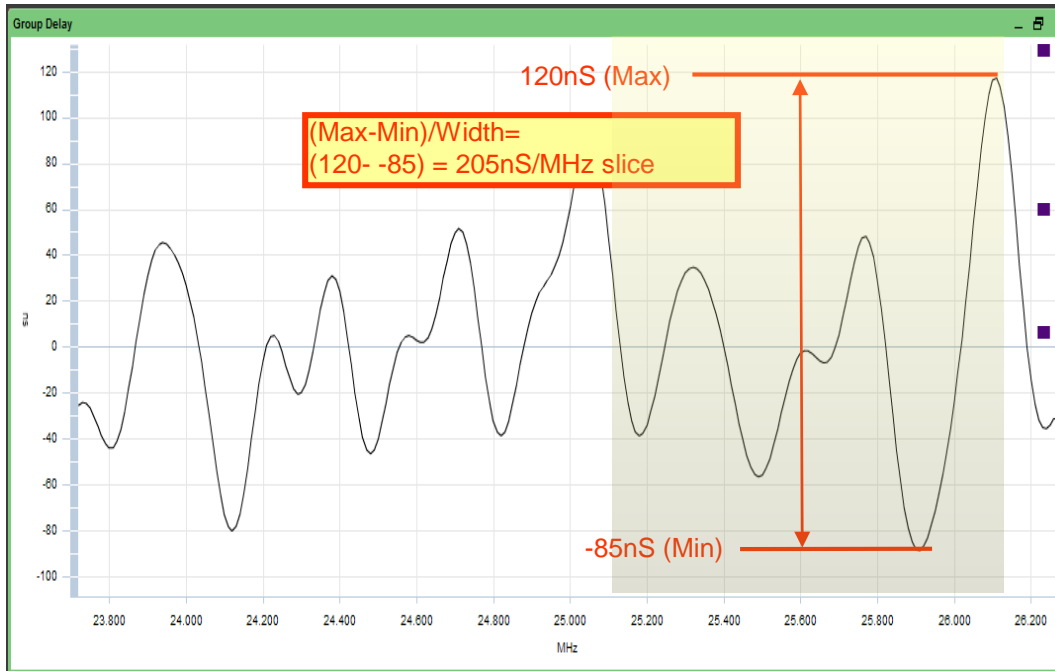

- Chart displays the delay of the signal from the CM to RPM3000 over the frequency of the carrier

- Chart is generated from equalized data (vs unequalized data)

- Common Causes:

- Operation too close to duplex roll-off
- Defective duplex filters
- Notch Filters
- Microreflections

- X-Axis: Frequency (covers frequency range of the carrier)

- Y-Axis: Delay of the signal in nS at each frequency

- Interpretation:

- Max peak to peak variation across the entire carrier frequency can exceed Threshold value and still not fail

- Remember: Pass/Fail is based on peak to peak per 1MHz slice of spectrum

Why Use Adaptive Equalization?

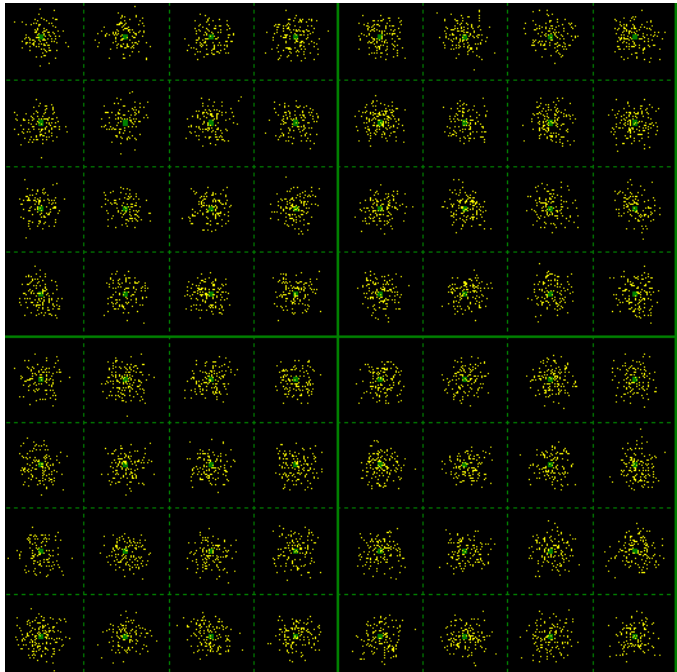

No Equalization
25.2 dB MER

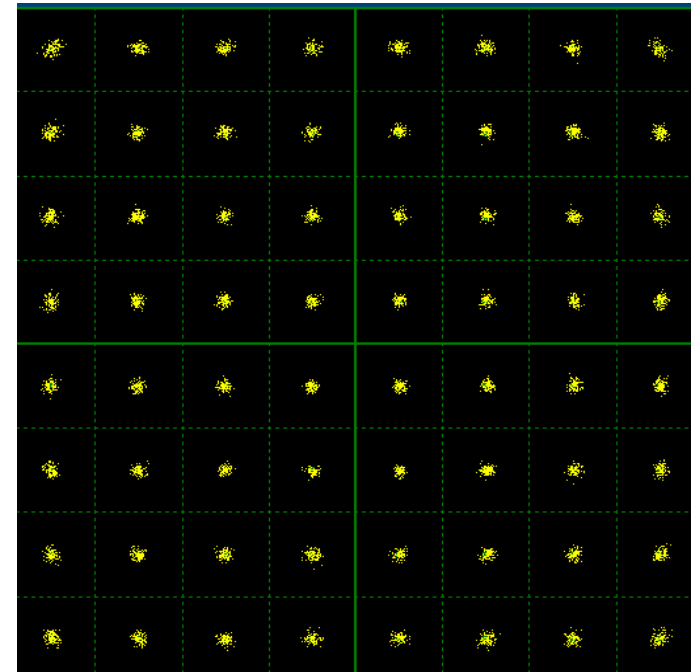

After Equalization
>40 dB MER

AE Summary

- AEs are found in virtually all digital receivers including field test equipment, modems, and CMTSs.
- AEs compensate for linear distortions only
- They eliminate linear distortions by generating a signal that is 180° out of phase with the reflected signal and combining it with the original.
- The more taps, the better the equalization
- Linear Distortions cause codeword errors, cannot always be seen in spectrum analysis, and they should be tested in the upstream

Upstream Pre-Equalization

Pre EQ and Adaptive EQ at the CMTS

CM pre-equalizer
does most of
correction

*Equalizer
response gives
information about
cable channel*

CMTS
post-equalizer
cleans up residual

Pre-Equalized Frequency Response

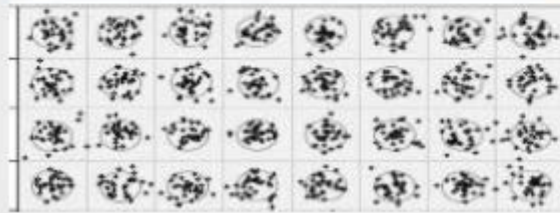
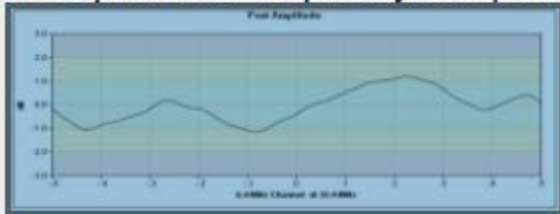

Post-Equalized Frequency Response

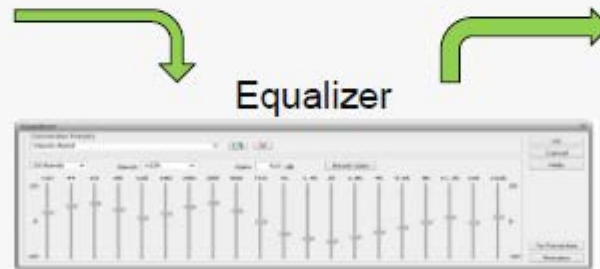
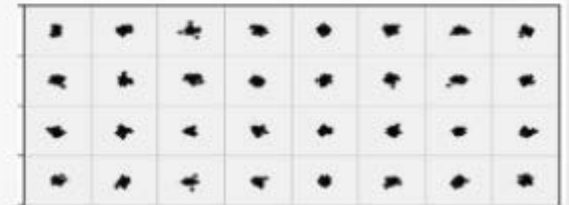
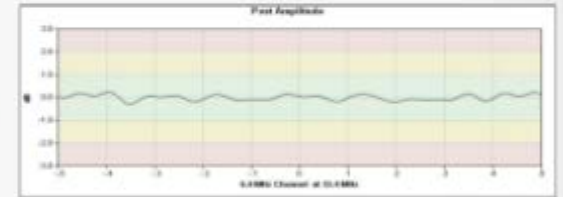

Source: Larry Wolcott, Comcast

Modem Pre Equalization

- The intent is for the CM to use its pre-equalization coefficients to pre-distort the upstream signal so that it cancels out linear network impairments. So when an upstream signal travels through the network, it arrives distortion free at the CMTS.
- In most scenarios, upstream pre-equalization can completely compensate for certain problems in the network and as a result, no symptoms are detected at the CMTS in FEC statistics or through other metrics.
- The fact that pre-equalization can usually fully compensate for network linear distortions buys the operator time in resolving the issues before they impact the quality of service.
- Pre Equalization also enables a proactive network maintenance. Operators can triangulate problems based on the modem Pre EQ coefficients of the taps.
- **If pre-equalization is enabled, it turns every cable modem in the plant into a device capable of doing basic upstream signal analysis!**

How Cable Modem Pre Equalization Works

- When a modem is first turned on, it sends a ranging burst to the CMTS. (the outer 4 symbols of the constellation)
- The CMTS adapts its burst-receiver equalizer based on this ranging burst of each channel from the modem to the CMTS.
- The CMTS then sends the equalizer coefficients back to the modem, which it then loads into its pre-equalizer.
- Ideally, the pre-equalizer exactly corrects the response of the channel, and data that the CMTS receives from that modem are now free of linear distortions. The inverse of the modem pre eq response is the response of the system.
- The modem sends periodic ranging bursts so that the CMTS can "tweak" the pre-equalizer coefficients. However, this can take some time.

Cable Modem Pre-Equalizer

- When PNM is used to look at the pre equalization coefficients, the approximate distance from a reflection point in the upstream to an impedance mismatch can be determined.
- Each one of the taps of the pre-EQ represents a period of time
- Taps of the EQ that contain more energy represent the distance from a reflection point.
- 6.4 MHz 64 QAM signal uses 5.12 MSs
- This equates to a symbol being transmitted every .192 μ Sec ($1/5.12\text{MSs} = .192\mu\text{sec}$)
- So if we know the VOP of the cable, we can then calculate the distance to the impedance mismatch.

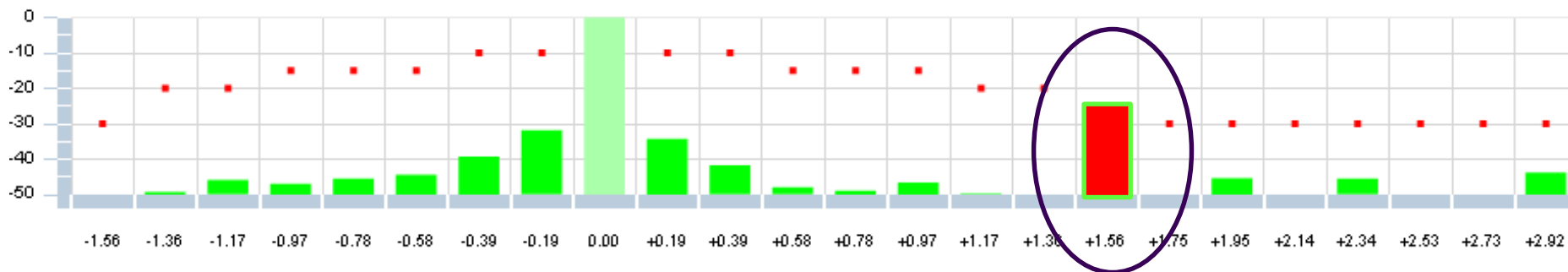

Distance calculation from an upstream reflection point

- $$\frac{(192 \text{ nSec.} \times .87 \text{ VoP})}{2} \approx 85' \text{ per tap 64 QAM Upstream}$$

- The distance from the reflection point $\approx 680'$

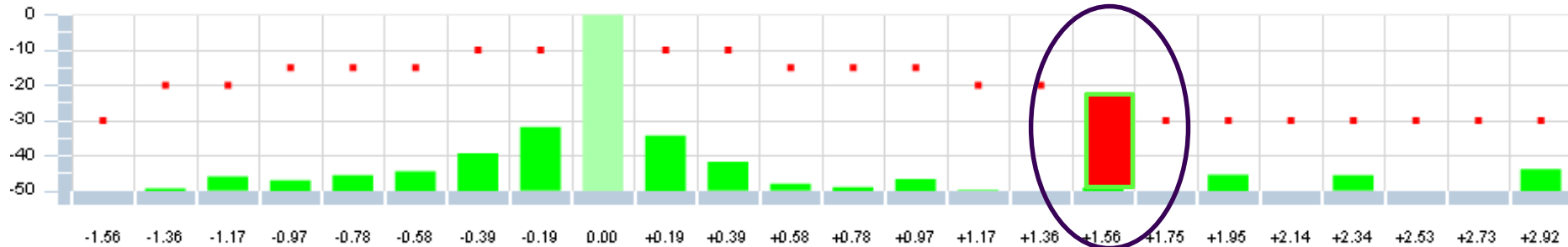

Upstream Modem Pre EQ Coefficients

Amplifier as the Reflection Point

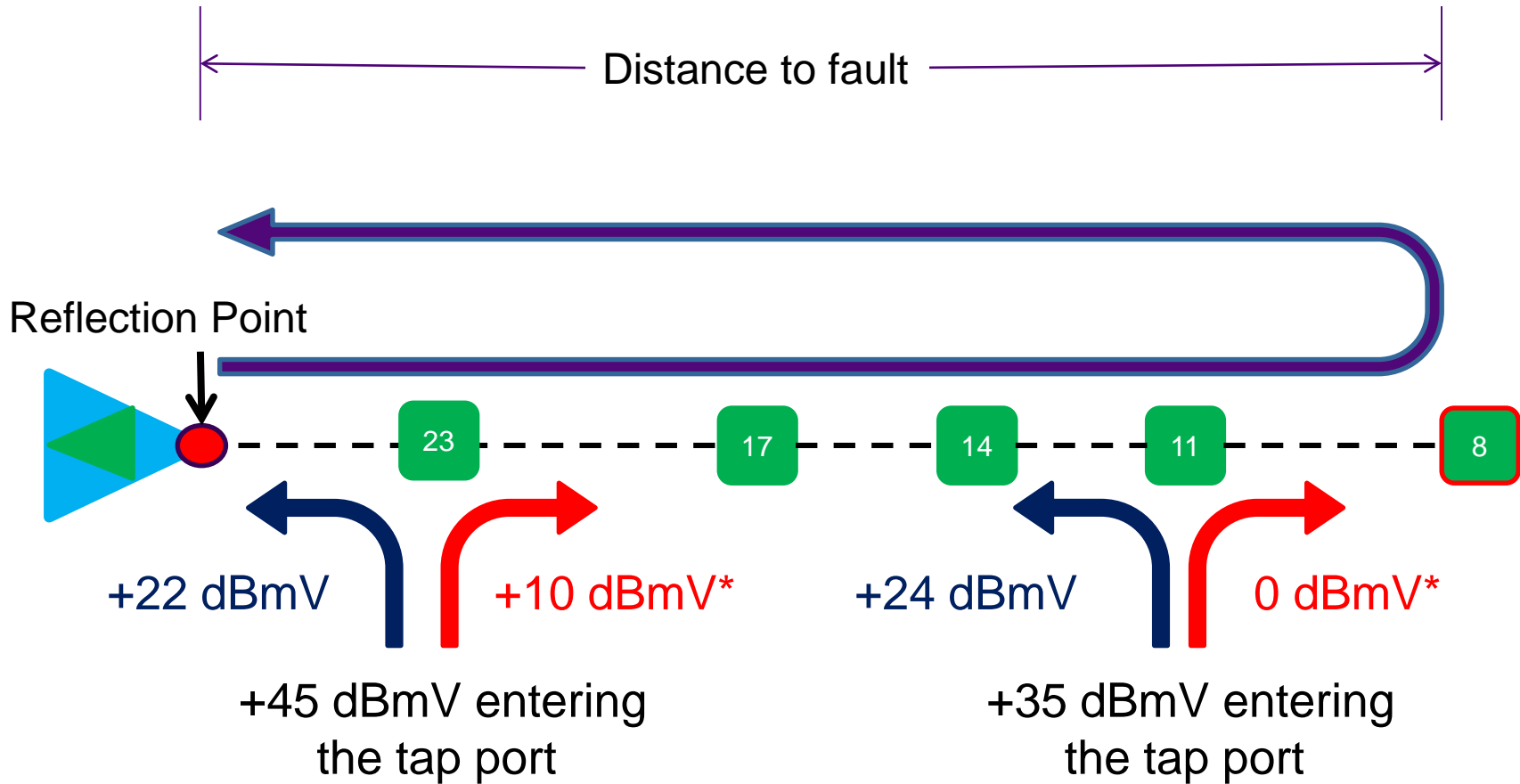

*35 dB tap to output port isolation

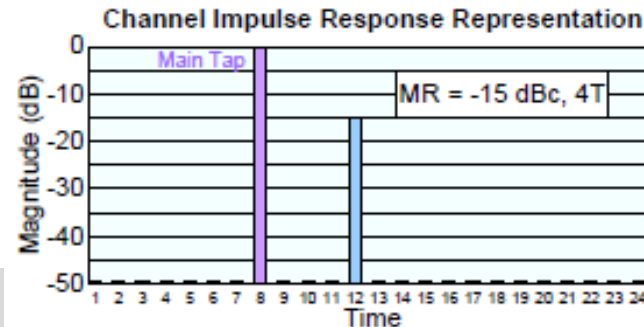

Reflective Cavity in the upstream

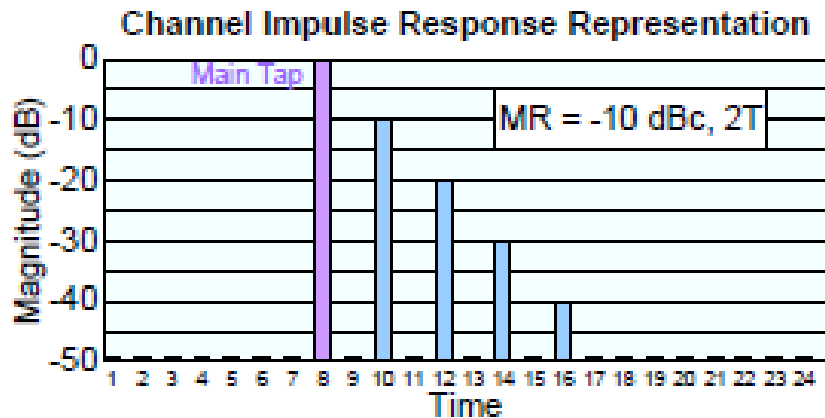
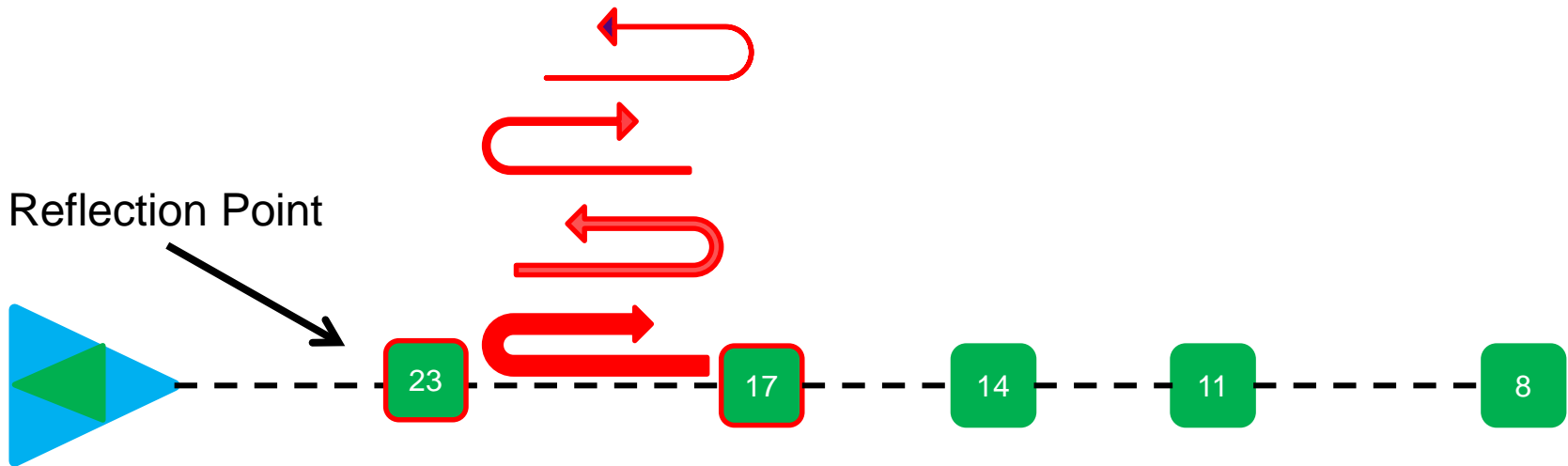

All modems past the 23 tap will Show the same distance to the reflections

Pre EQ Summary

- Equalizer on the transmit side of a modem
- It pre distorts upstream signals that cancel the effects of upstream linear distortions.
- The Pre EQ is maintained and controlled by the CMTS
- By looking at the Pre EQ coefficients, we can approximate the distance to a reflection point.

PNM Upstream Process

Why PNM? (Preventative Network Maintenance)

- Cable operators require remote visibility into operation of cable plant and equipment
- Provide test points in CMTS and Cable Modems to enable characterization and troubleshooting of HFC plant
- Provide characterization of cable plant response, linear and nonlinear, and noise/interference evaluation
- Support remote proactive troubleshooting of plant faults
- Goal is improved reliability and maximum throughput from well-maintained plant

Who uses PNM?

- CableLabs – Pre-EQ / SA Reference
- Charter – DRUM / Node Slayer
- Comcast – Scout Flux / Spectra
- Cox – Edge Health
- Time Warner Cable - ROI / Unified

6 Step Process

- Data Collection
 - SNMP queries of the CMTS and Modems
 - EQ and Pre EQ coefficients, Center Freq, and Bandwidth of the carrier
- Initial Distortion Assessment
 - Which modems need to be monitored more frequently
- Detail Analysis
 - distortion signatures from frequency and time domain analysis
- Classification Evaluation
 - Triage, red, yellow or green
- Modem Pre EQ Comparisons
 - Compare modems with similar Pre EQ coefficients for distances
- Plant Topology Correlation
 - Plot the modems with colors on a system map

CM and CMTS Signatures, Queries

CM : Displays cable modem frequency response and adaptive equalization of the modems at the selected frequency and severity level

CMTS: Displays the Cable modem performance as received at the CMTS

Displays table information for all modems on selected frequency

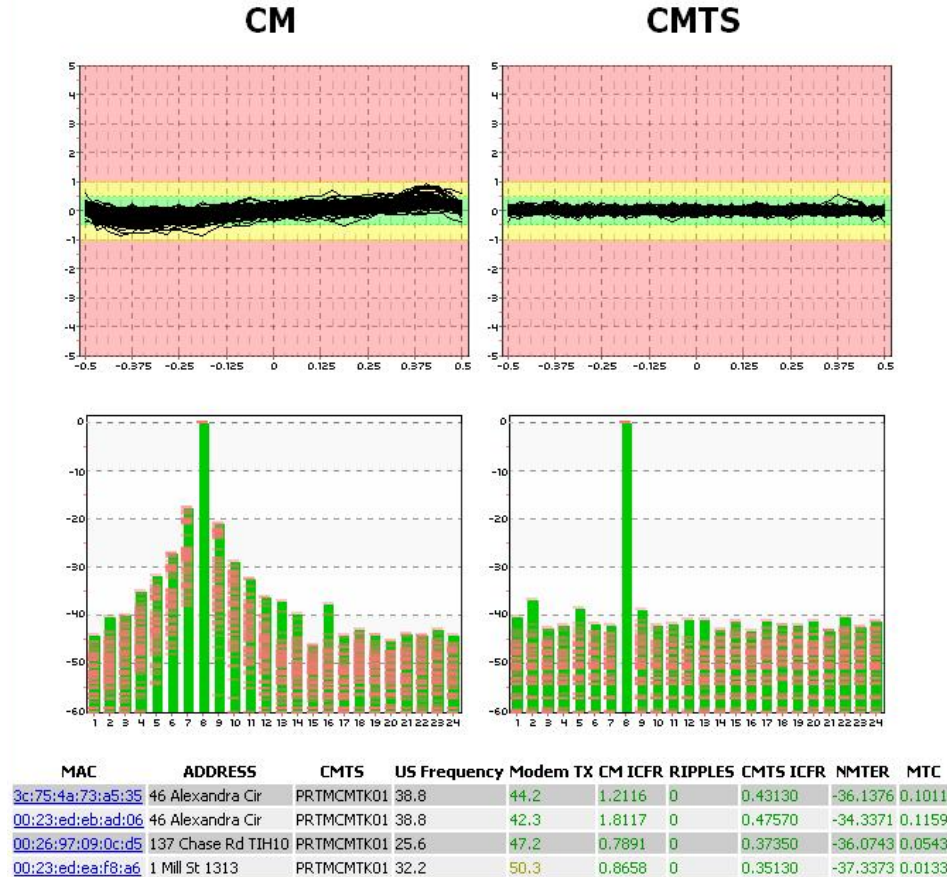

Analysis: Pre Equalization Examples

A bad in home issue will look like this

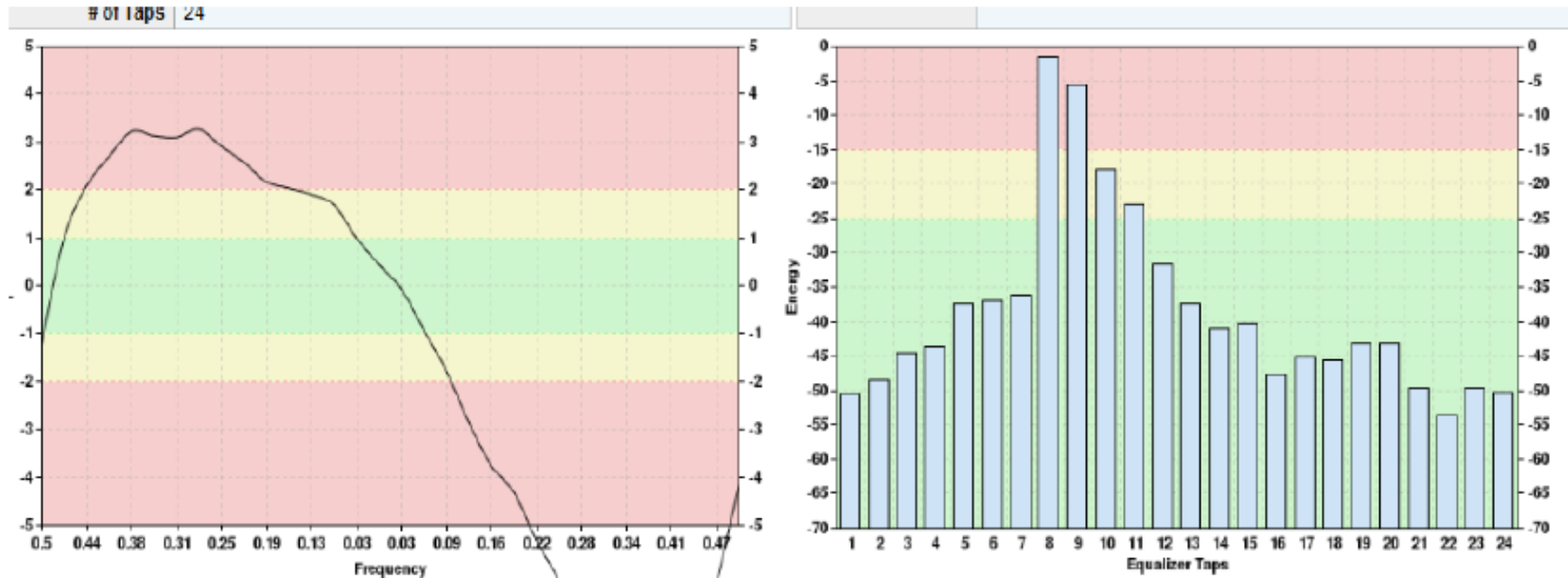

Analysis: Pre Equalization Examples

A problem close to the tap will look like this

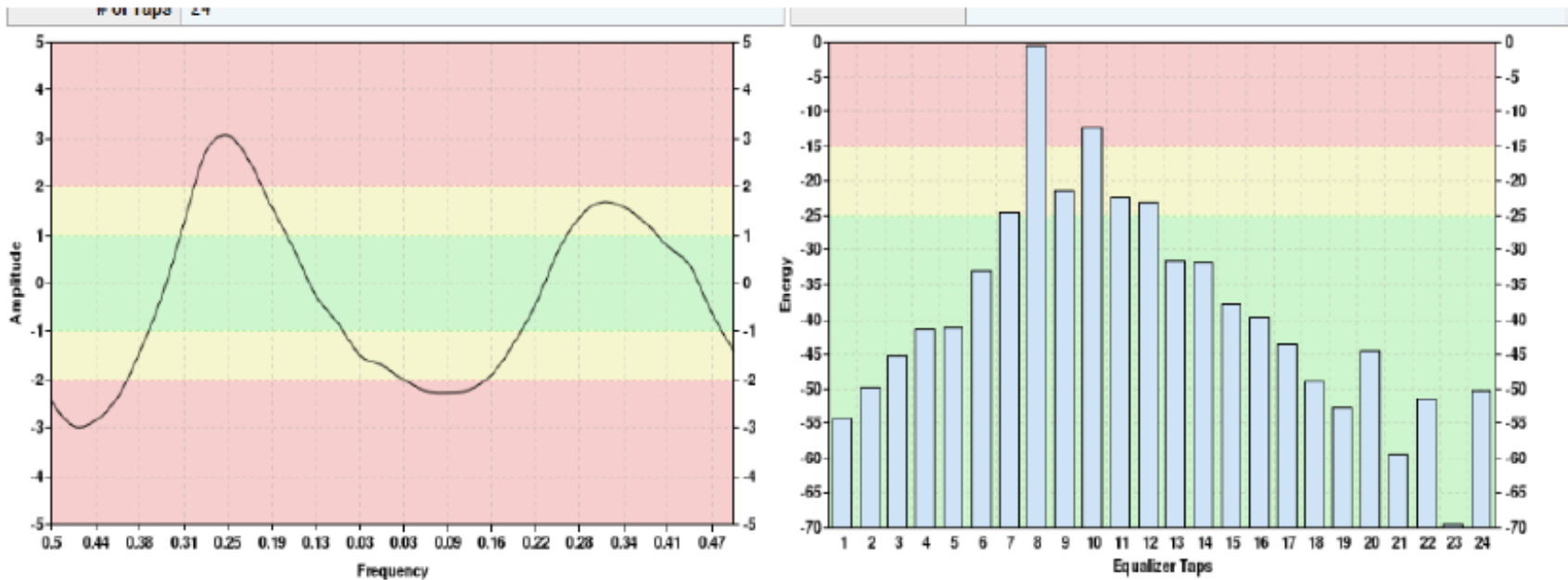

Analysis: Pre Equalization Coefficients, Reflective Cavity

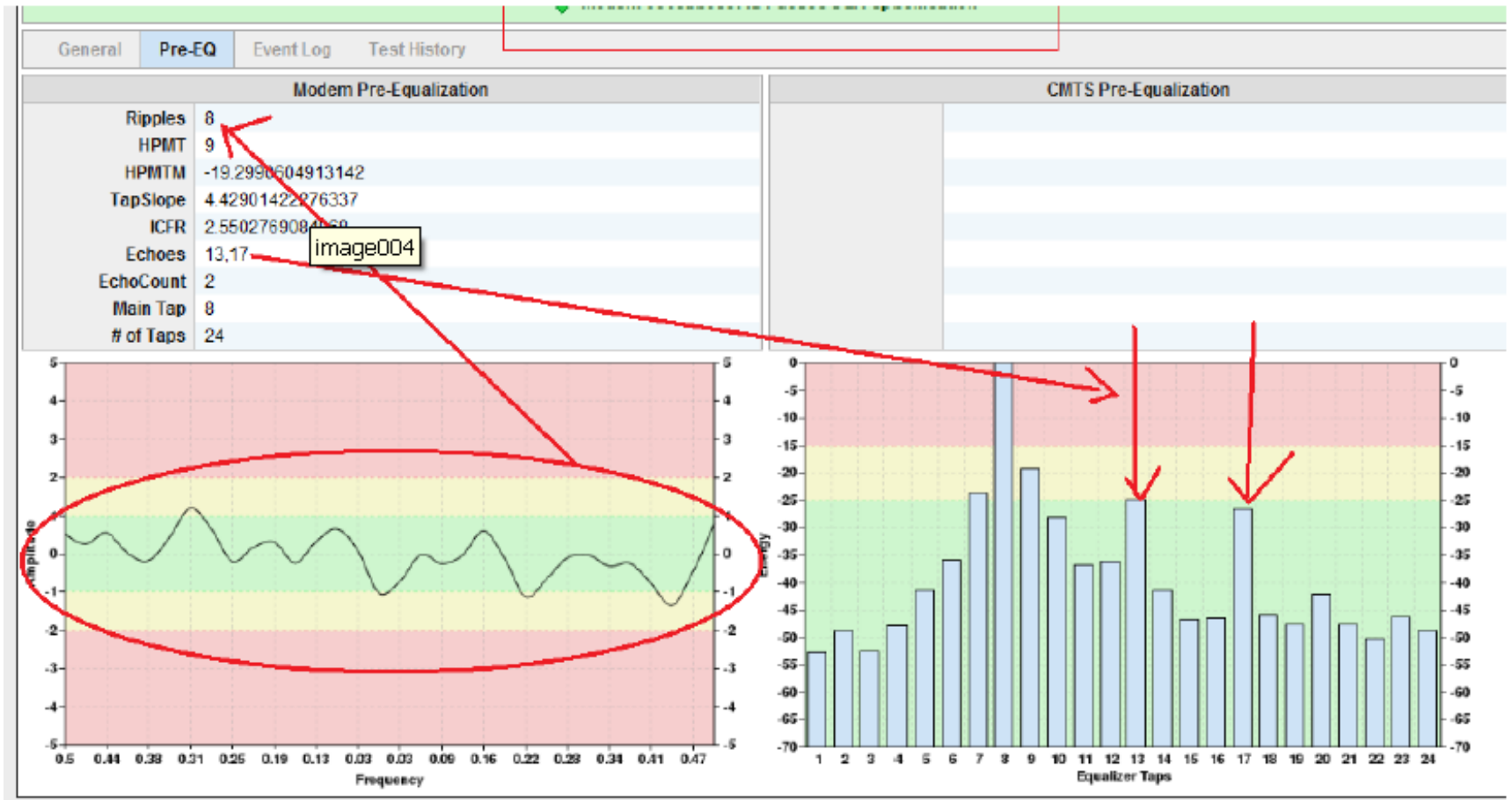

Analysis: CM Pre Eq Amplitude Response Analysis

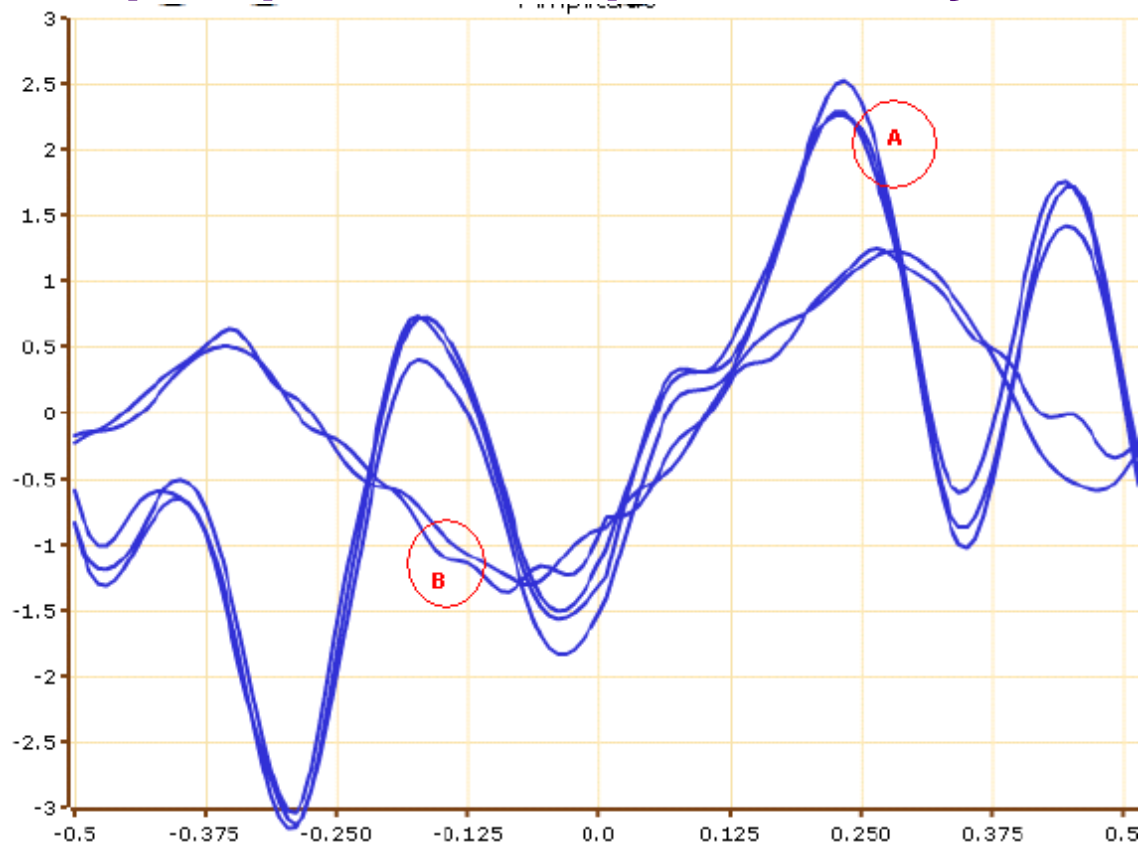

- This display of the amplitude response of several modems shows 2 different reflections.

Bad modems plotted on a map

Many of the modems in this neighborhood shared the same response/issue.

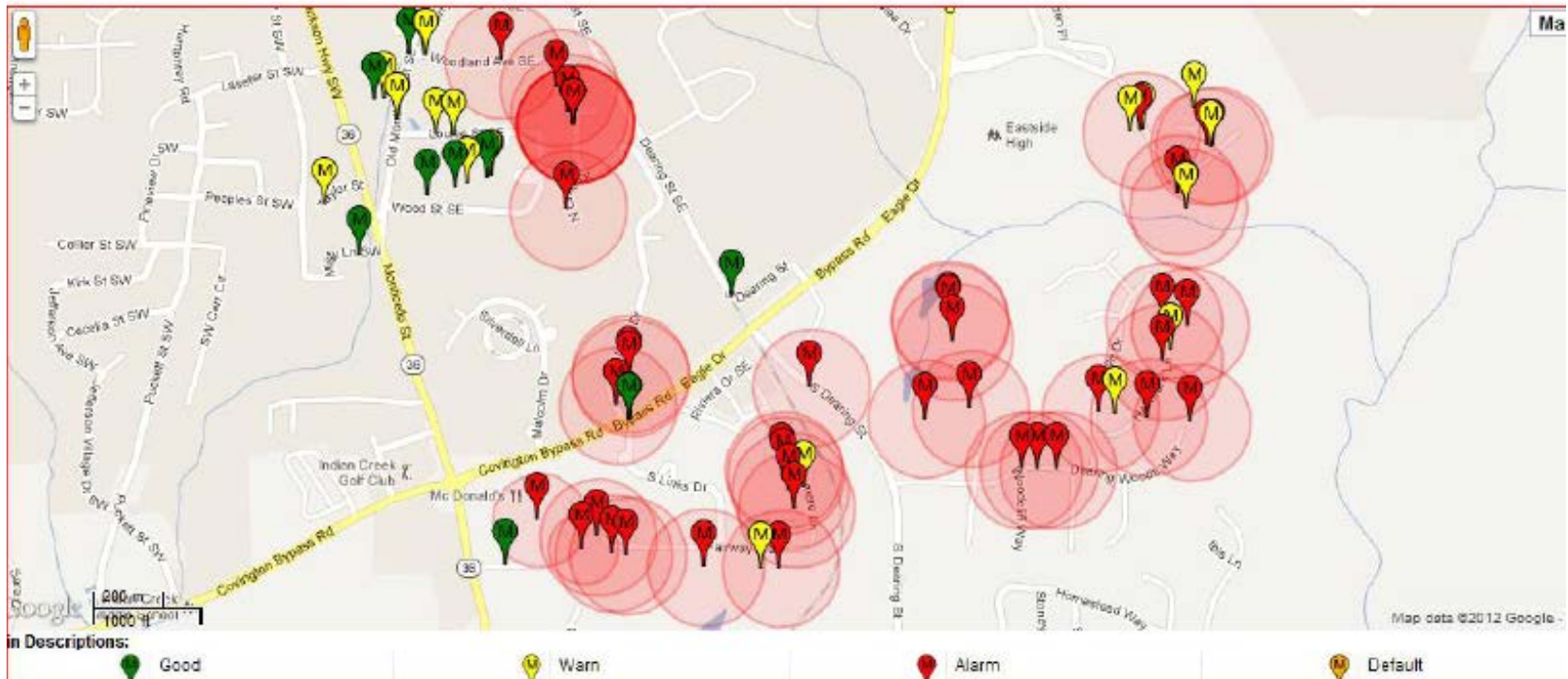

Before and After Levels and MER OK

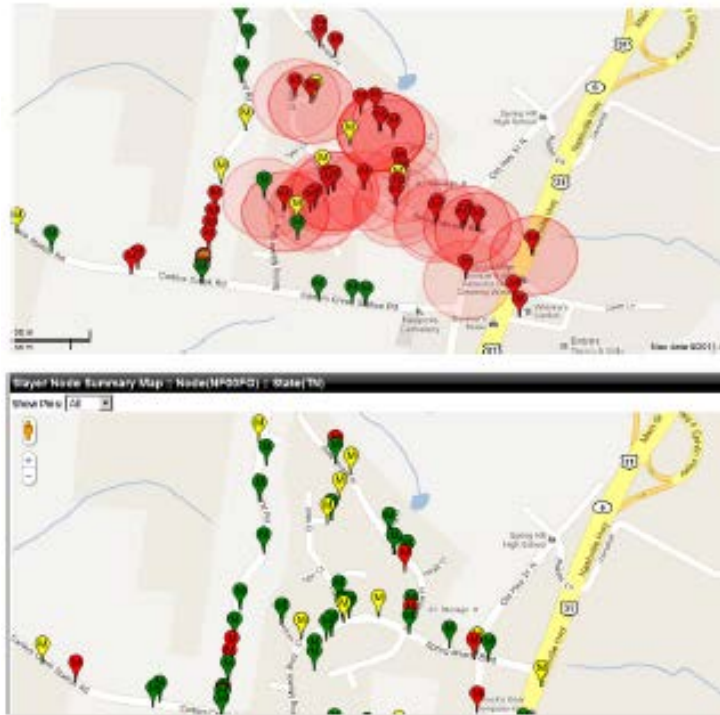

Finding

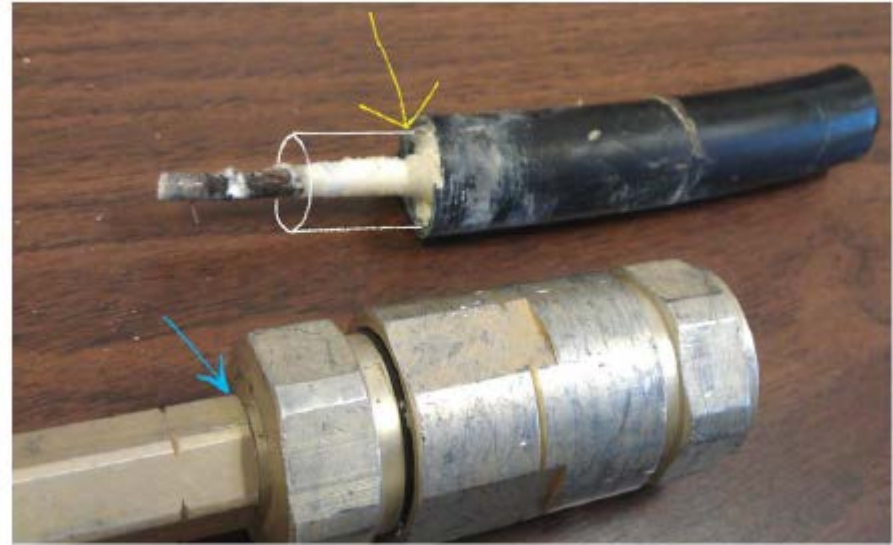

A crack in the cable behind the connector shown by the blue arrow Allowed water migration and thus corrosion.

Upstream Monitoring Tool - Before and After Fix

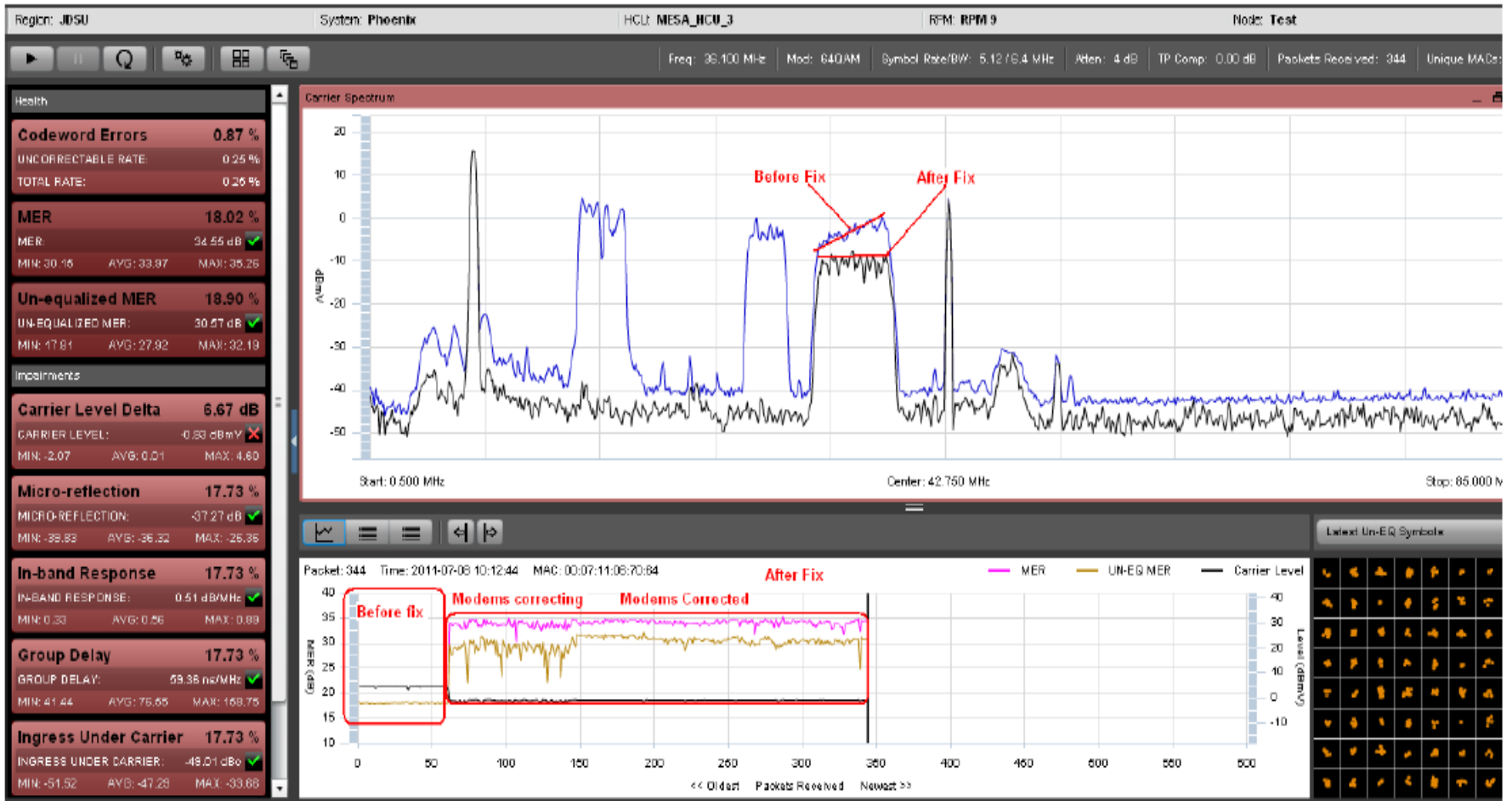

Downstream PNM

- With newer chipsets in modems and gateways, an SNMP query can be made and those chipsets will return a downstream spectrum display.
- These downstream spectrum displays can be analyzed for problems such as:
 - Ingress
 - LTE interference
 - Headend alignment issues
 - Reflections caused by impedance mismatches
 - Roll offs
 - Etc.

CPE Downstream Monitoring before and after

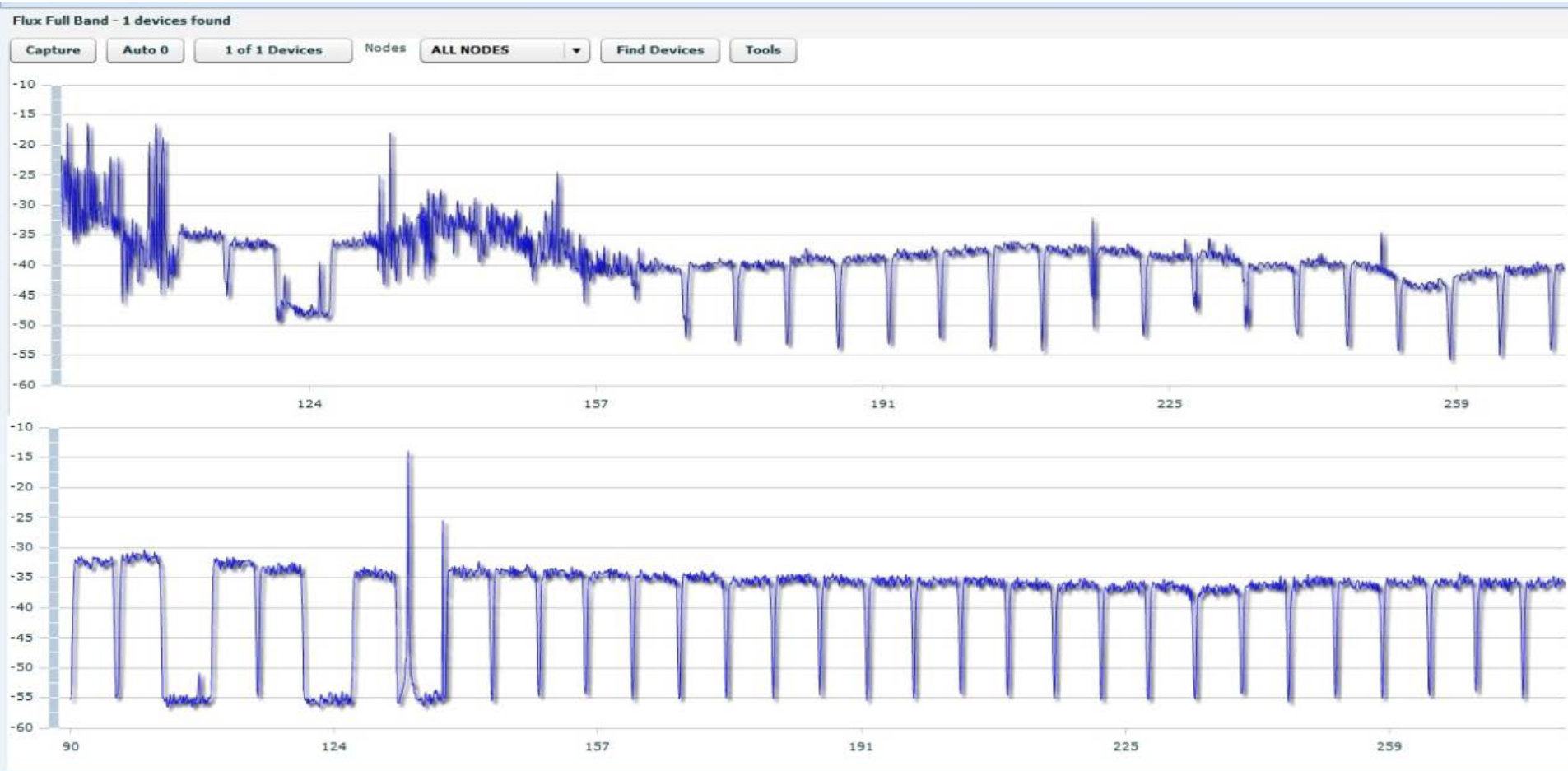

Source: Larry Wolcott, Comcast

PNM Downstream Examples



Reflections

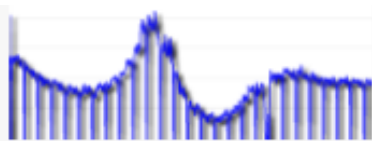

Resonant Peaking



4G LTE Ingress

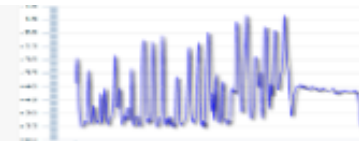

FM Radio Ingress

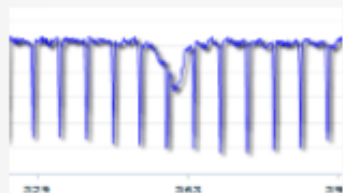

RF Notches



Roll-off

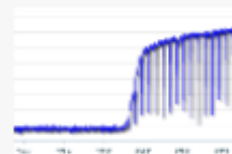

Filters



Adjacency

Source: Larry Wolcott, Comcast

PNM Summary

- Uses modems as a monitoring devices
- Modem upstream Pre EQ coefficients provide footages to a reflection point.
- Received signals at the CMTS are also analyzed and can distinguish between individual upstream problems

Troubleshooting Tips

Overall Troubleshooting Process

- Using PNM, localize problems and get reflection distances.
- Check system maps to identify possible reflection points.
- Use DSAM Equalizer function at amplifier test point to check distances to the fault.
 - Find and repair the fault
 - Verify Repair

Using the EQ function on a meter

- The downstream AEs in modern meters can be used to assist in troubleshooting reflections when PNM footages are not clear.
- Used by connecting to the test point of an amplifier and looking at the taps of lower and higher frequency channels.
- Makes trouble shooting easier, faster and less intrusive.
- Fix worst nodes quick and more efficiently.

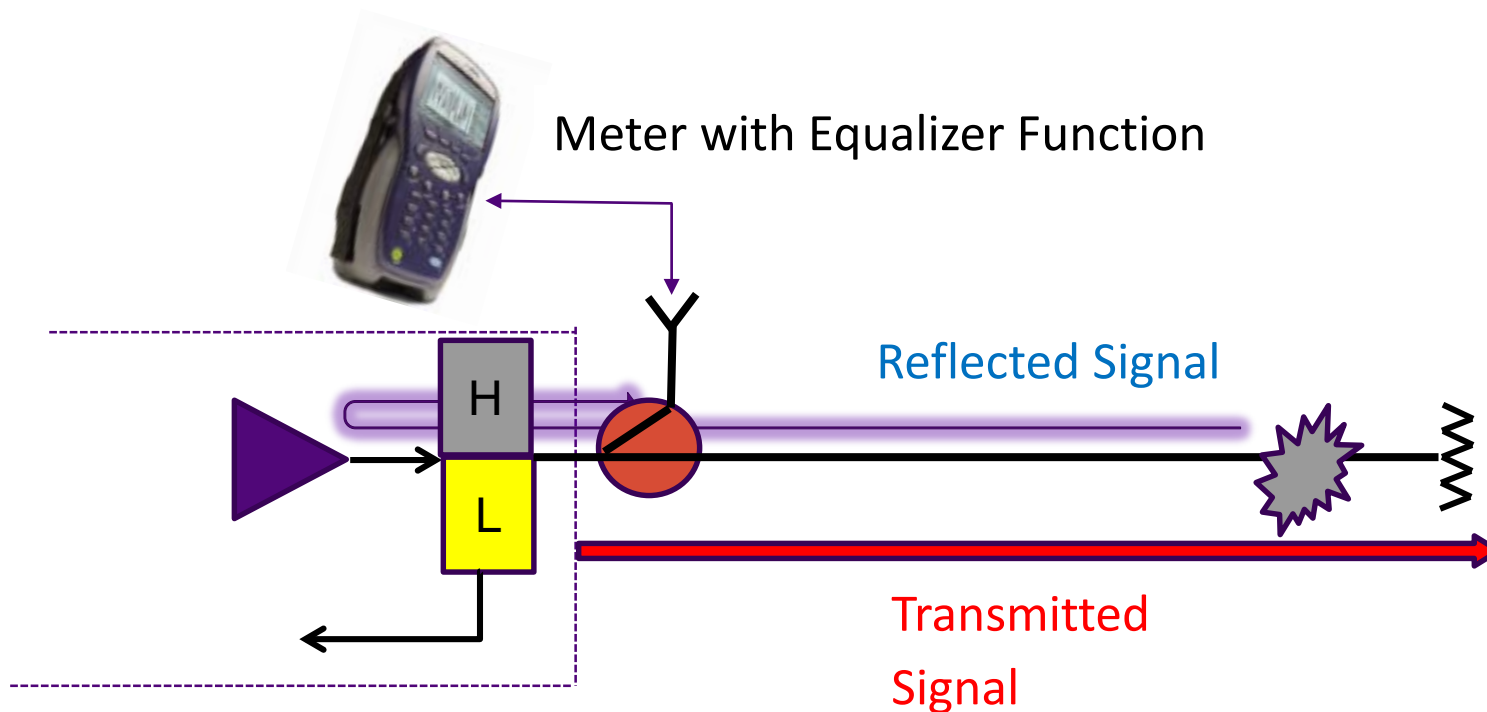

Steps for Using a DSAM Downstream EQ to localize issues

1. Use the visual / map based PNM methodology method to localize problem or problems and get reflection distances.
2. Check system maps to identify possible reflection points.
3. Use the Downstream Equalizer function at the amplifier test point to check distances to the fault.
 1. Choose a channel in the area of the spectrum that best displays a particular issue. Multiple channels should be checked as these issues can be frequency dependent. For example, a water filled tap will be more visible on higher frequencies.
 2. Set the VoP for the cable being tested
 3. Using the left / right arrow key, move the marker to the elevated tap
 4. Use the displayed footage and divide by 2. The footage is to and from the reflection point.
4. Correlate footage to system map if possible
5. Check input and output ports as an in home problem can mask similar signatures
6. Repair Fault
7. Verify Repair

Example 1 Step 2 System Map Analysis

- PNM shows a problem at 720'.
- System Map show a splitter at 720'. The problem was at the splitter.
- Tech would normally have gone to the terminations first wasting time and effort.
- Before using the AE, his next step would have been to TDR the cable.

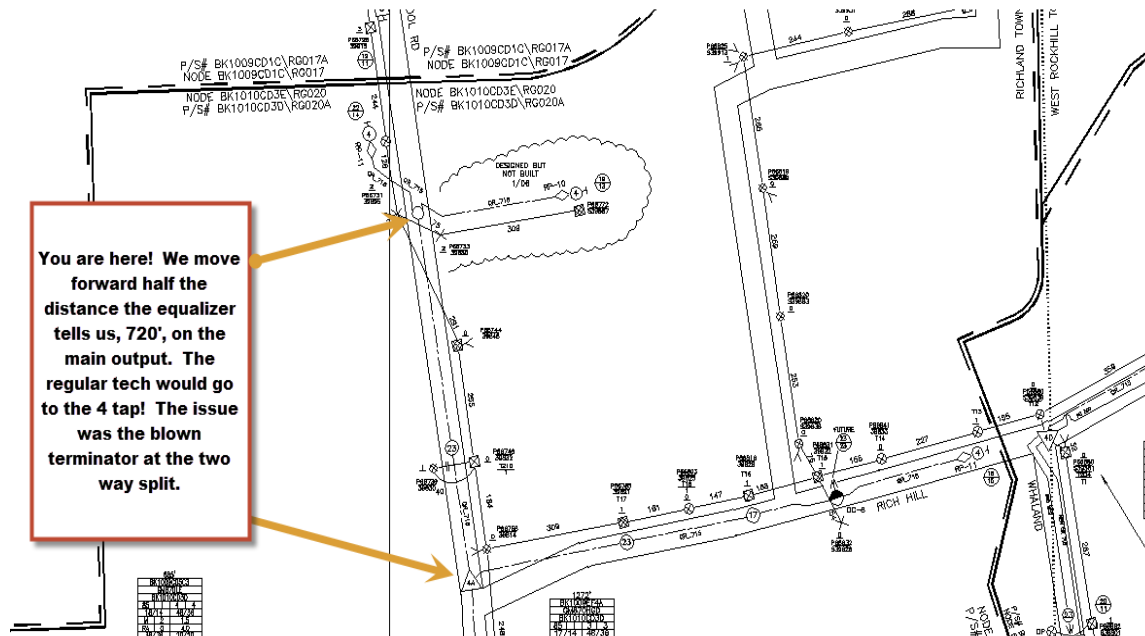

Example 1 Step 3 EQ before repair

- Major tap fault at 1437' marker with the Equalizer.
 - Remember VoP setting
 - Check more than one channel
- In older versions before 4.3, divide distance by 2. The distance displayed is the distance to and from the impedance mismatch in some equipment.

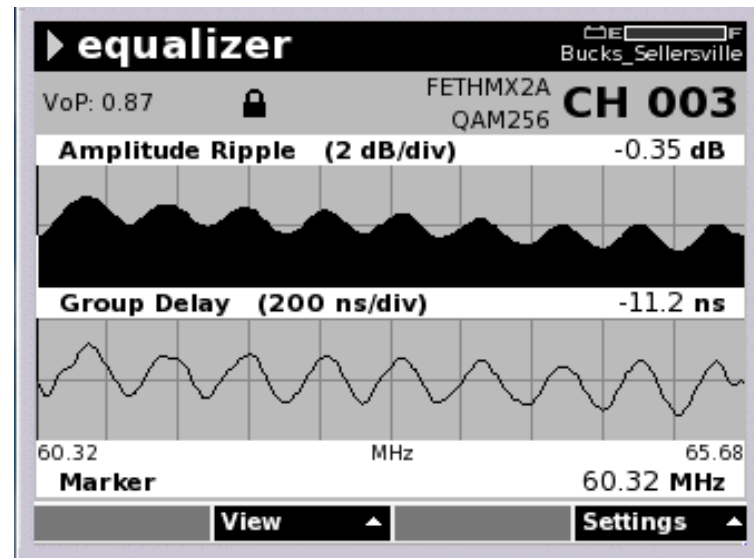
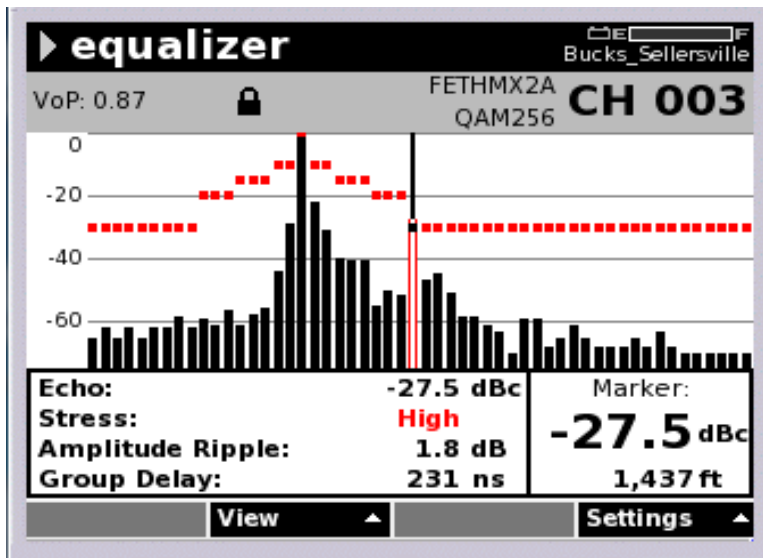

Example 1 Step 7 DSAM EQ verification after repair

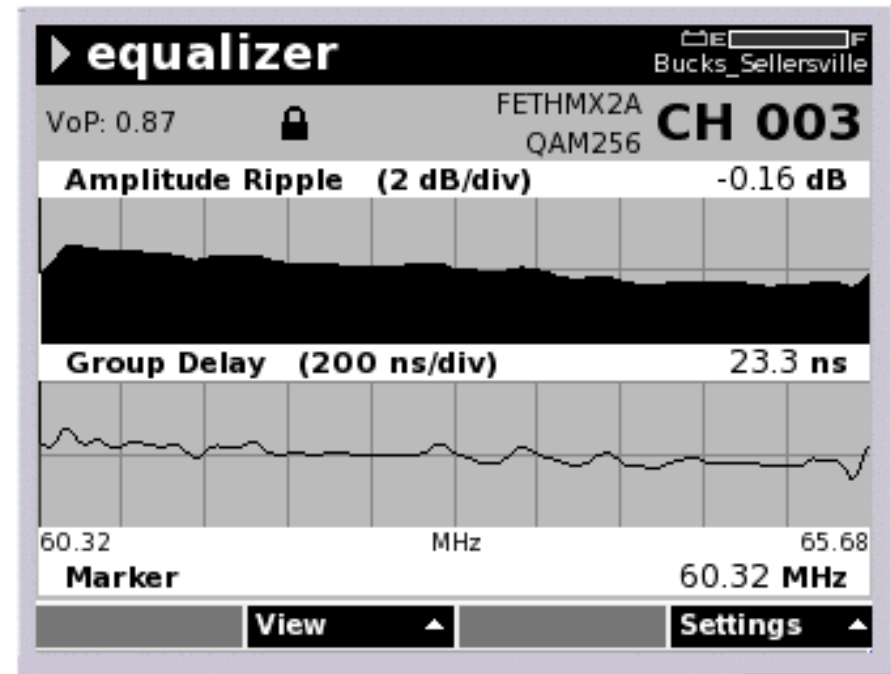
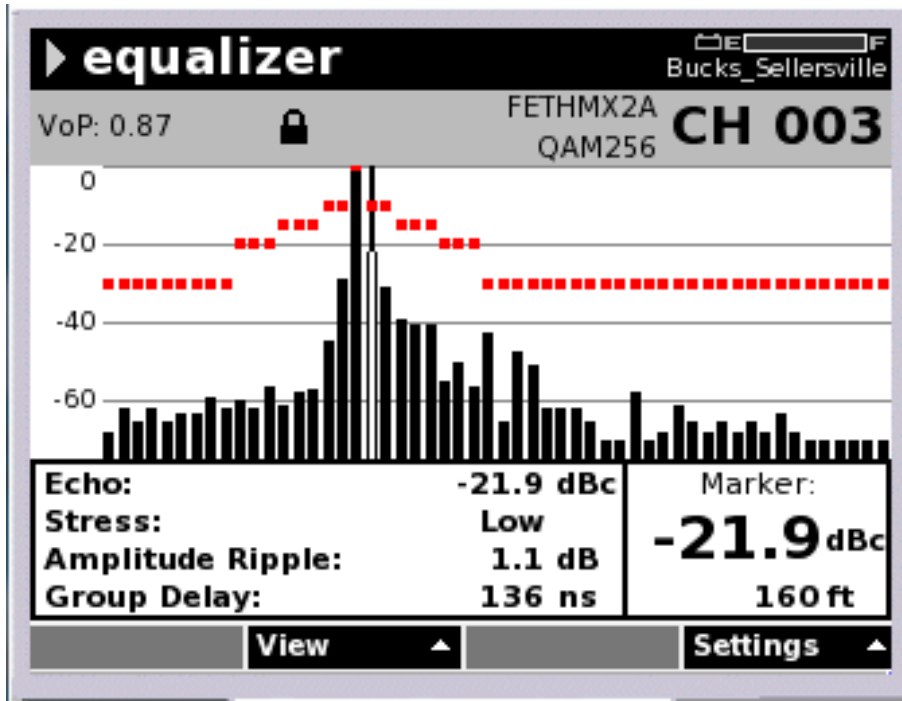

Example 2 Step 1 PNM analysis

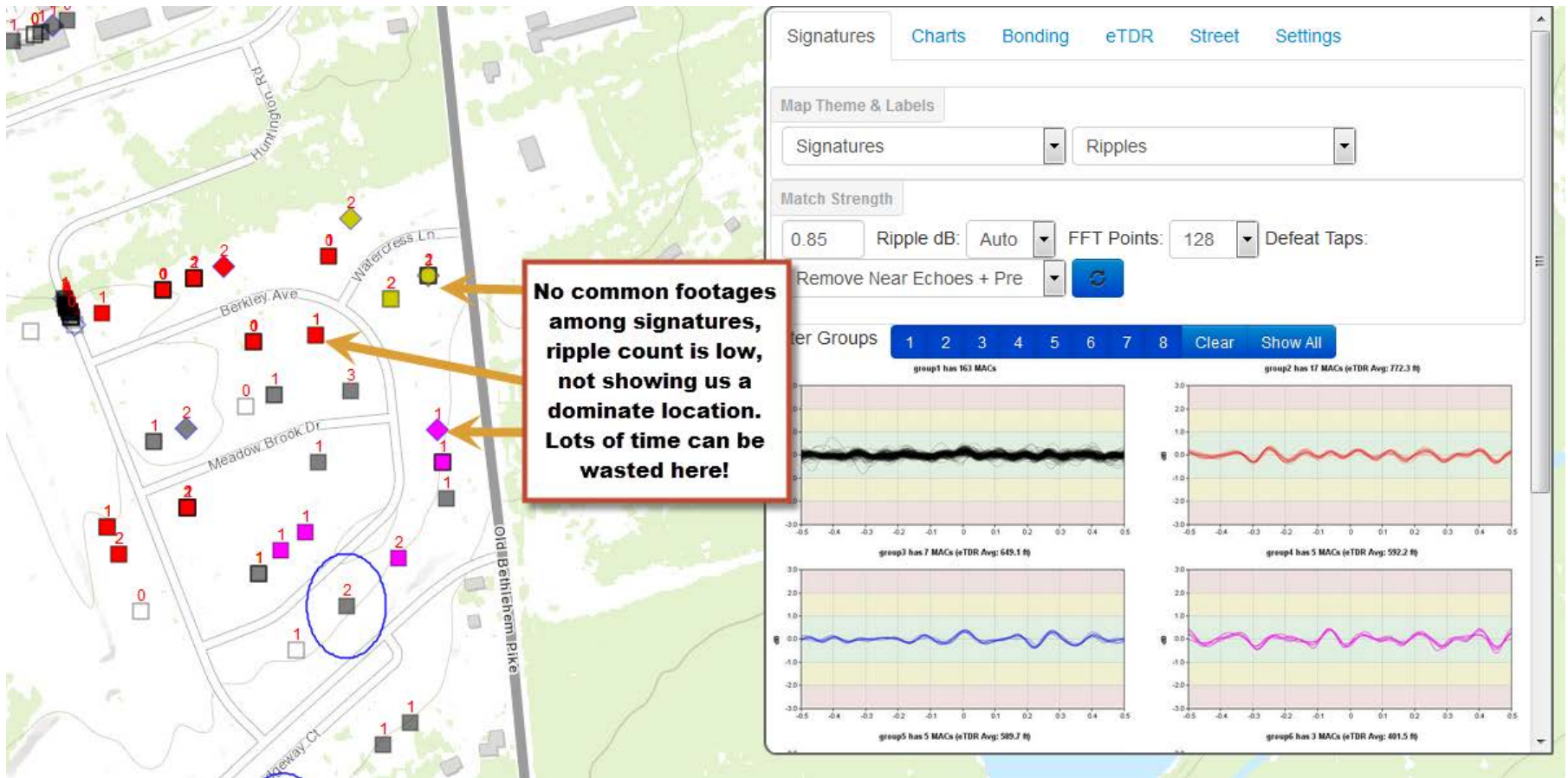

Example 2: Step 2 , The print and the repair

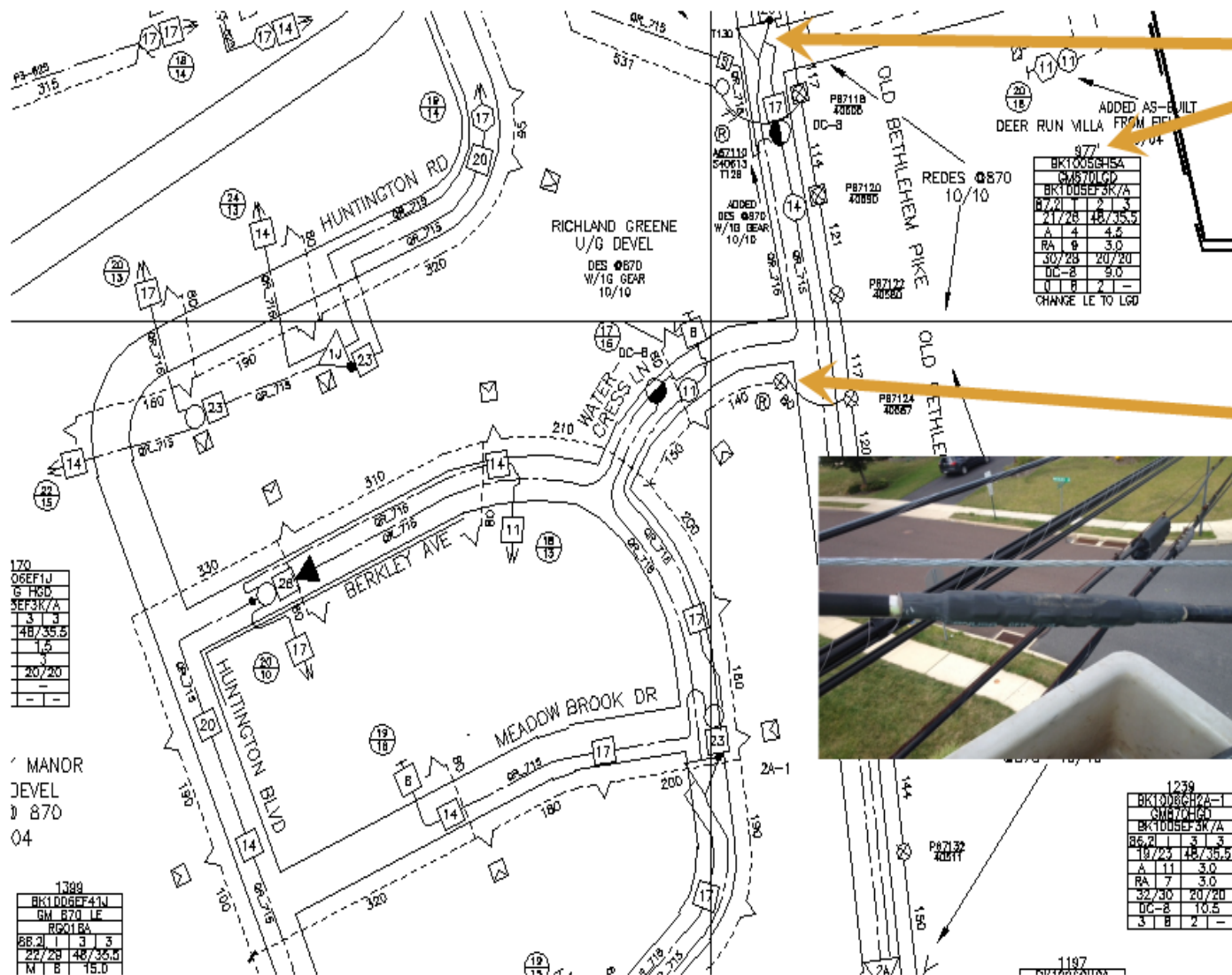

All devices shared this active, but all had mixed footages. Using the equalizer function at Amp 5A and 2A-1 we had a footage of 1115'. Half of that is 560. One common flux event was found also at 580'. A bad QR splice was found the rise pole, water...



BK
BK

Example 2 Step 3 DSAM Before repair

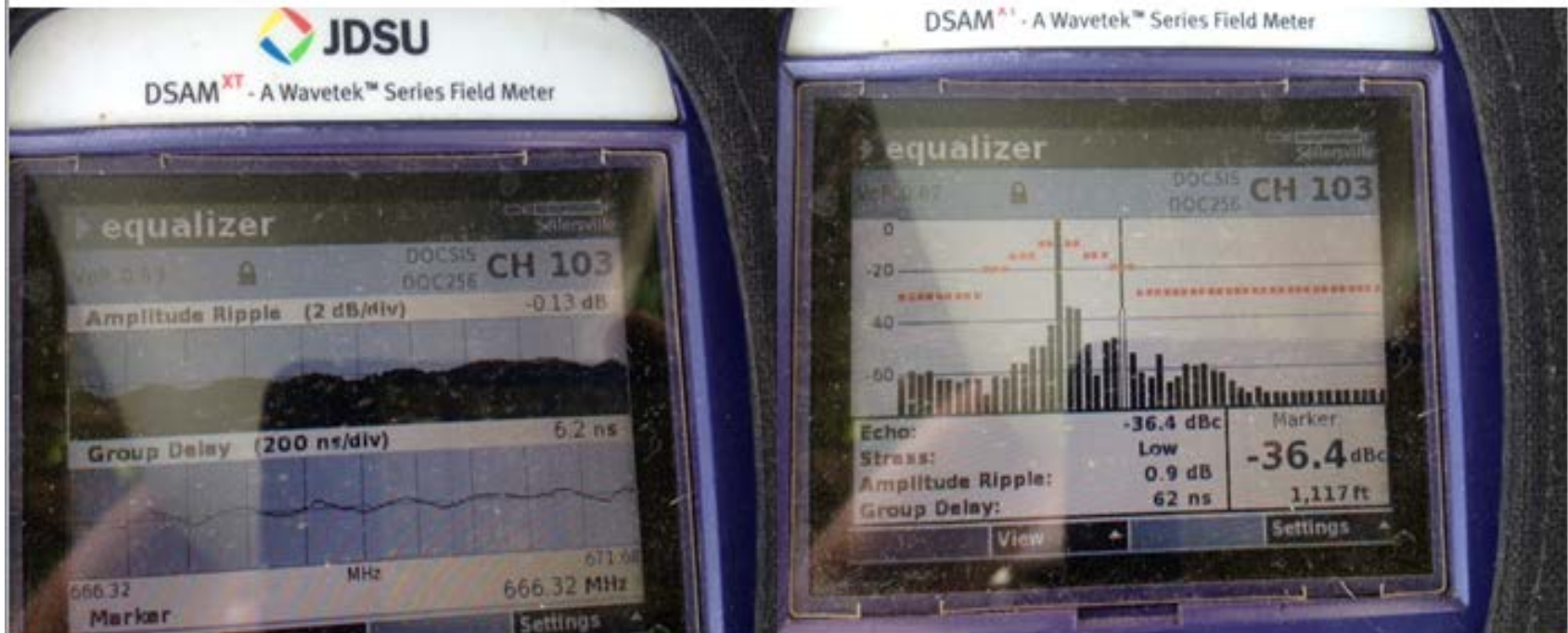

To the left is the wavy response of ch. 103, tell us there is an issue. To the right, is our tap/equalizer reading showing an issue at 1117'. This would be the distance to the reflection and back again. 560 away from me.

Example 2 Step 6 repair the problem

Bad QR splice at 580'



Example 2 Step 7

verification after the fix

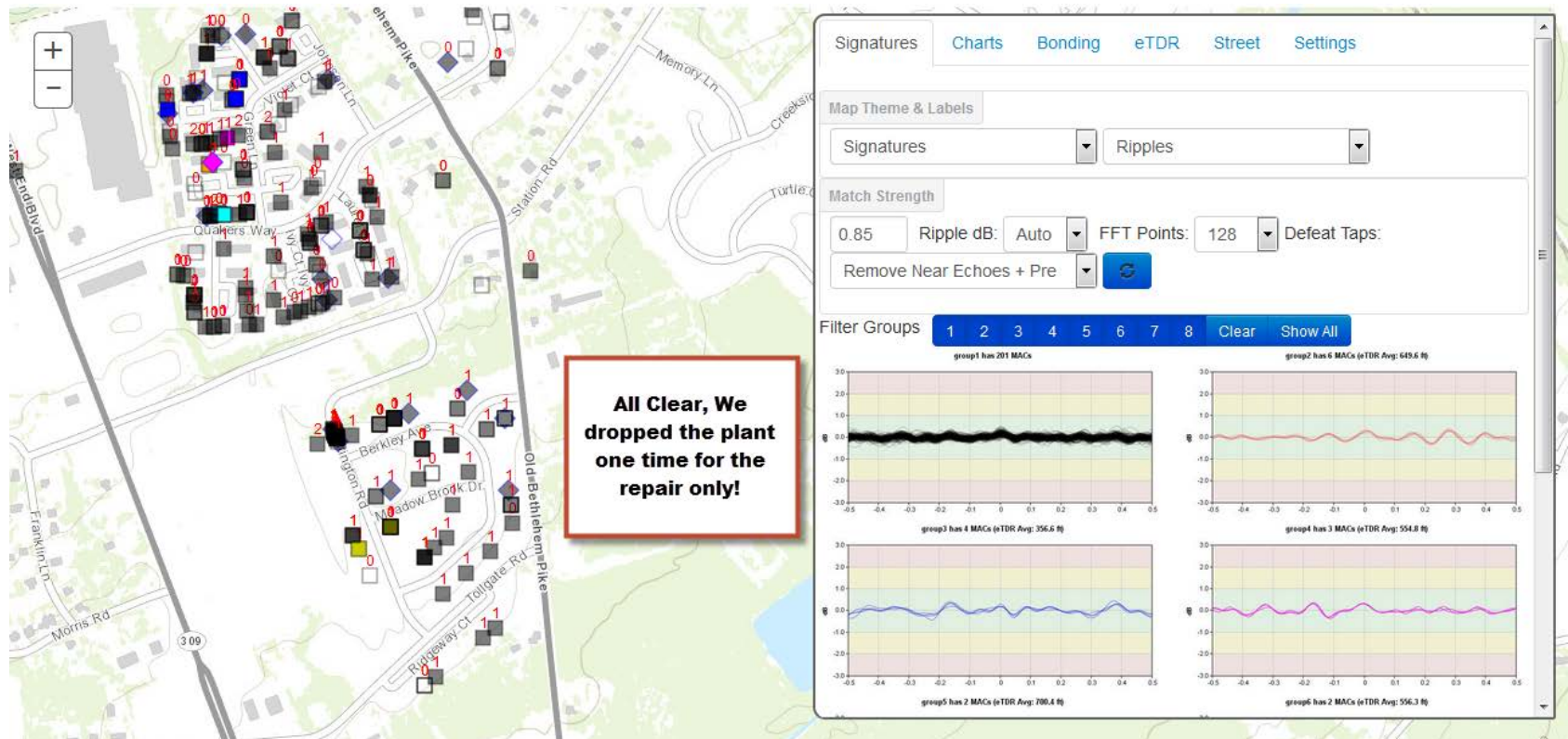

Example 3, Step 1: PNM Map Analysis

- PNM map showing an amplitude response issue

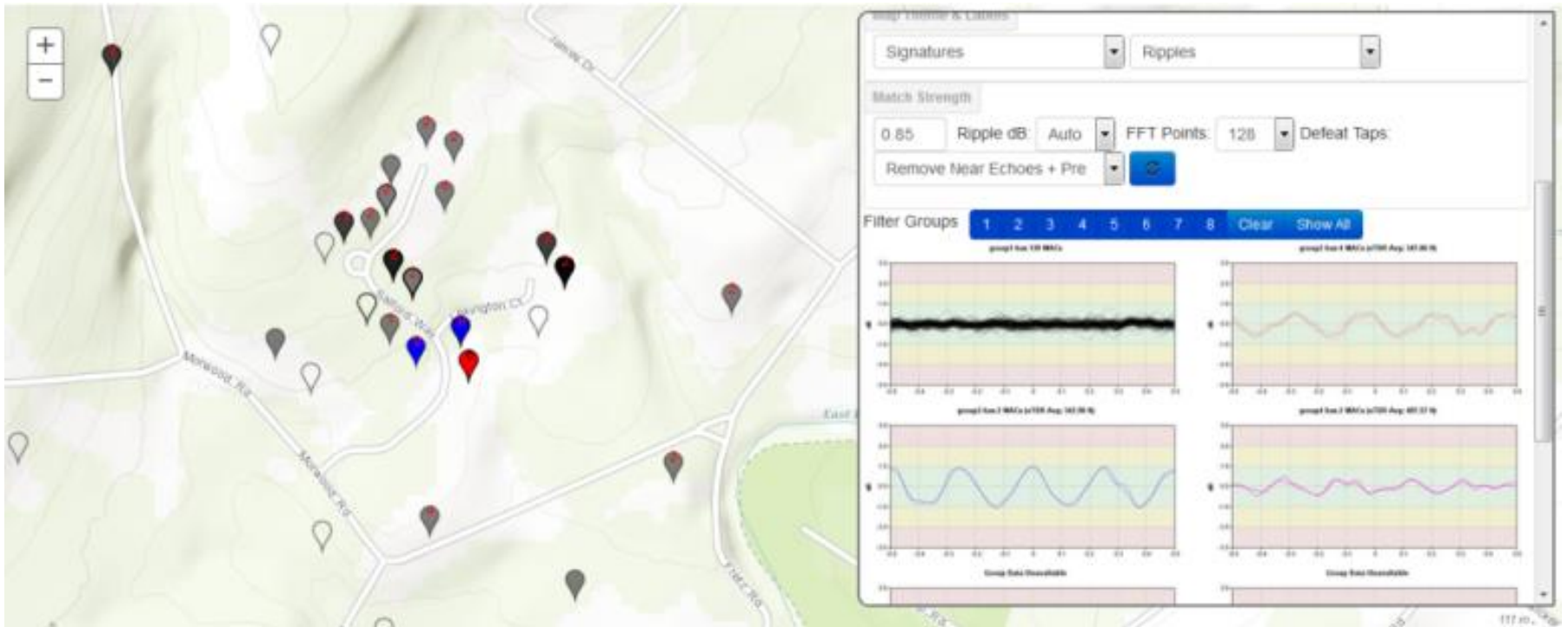

Example 3 Step 2: Analysis of the system map

- system map shows a distance of 370' to termination
- The actual footage was measured at 340'
- System map footages aren't always correct

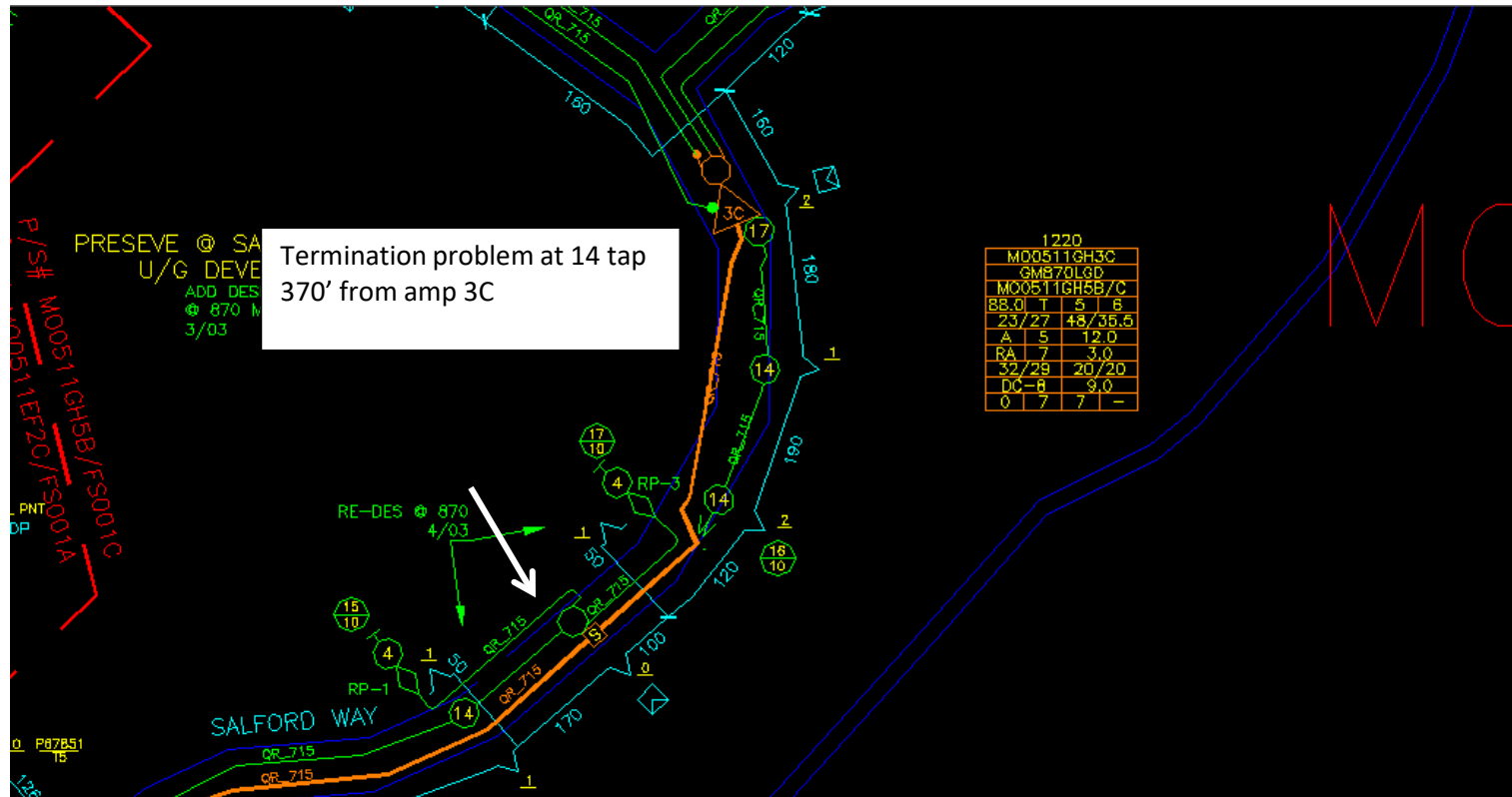

Example 3 Step 3: Using the DSAM Equalizer

- Amplifier 3C location showing a reflection at approximately 323'

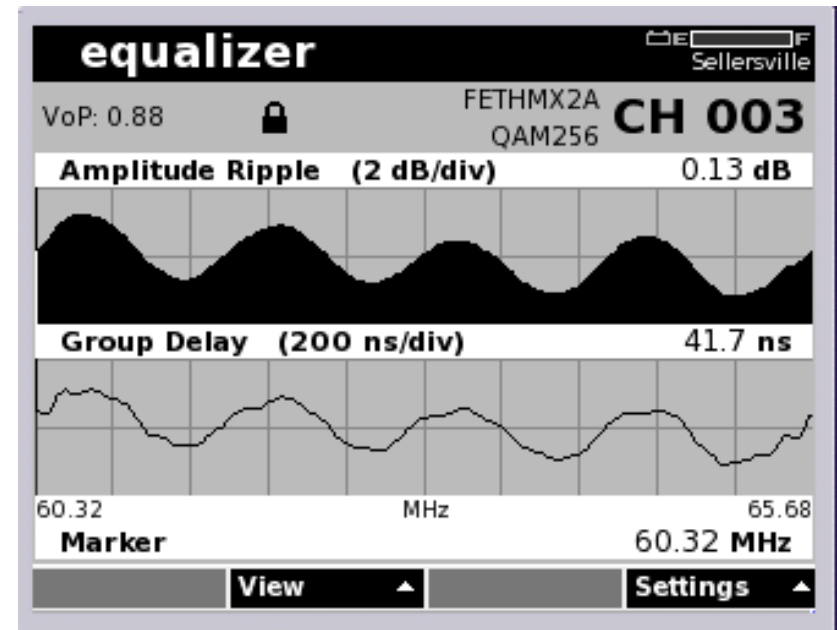
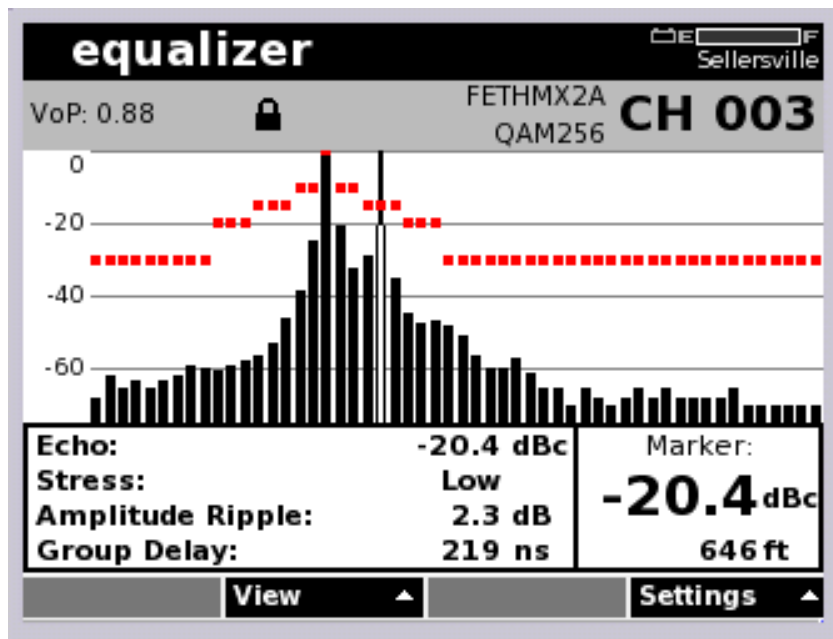

Example 3 Step 7 Verification of repair with DSAM meter

- Problem was blown terminator 320' away from Amp 3C

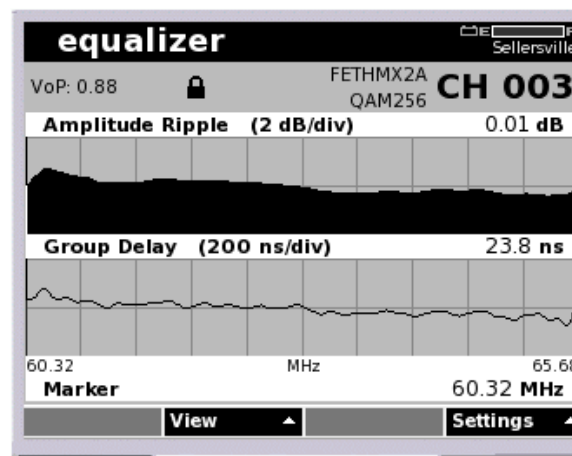
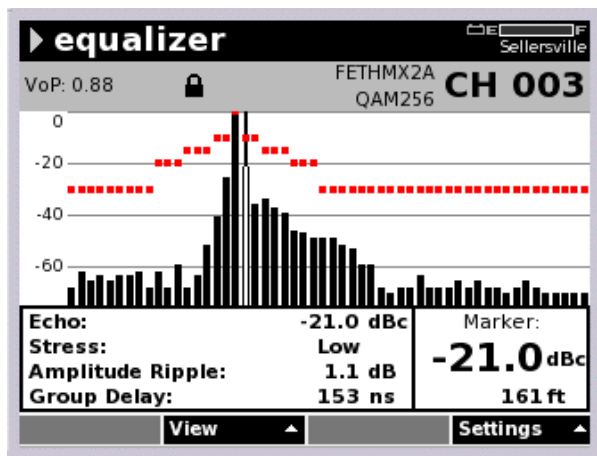

Example 3 Step 7 PNM Map Verification



Example 4 Step 1 PNM Analysis

- 2 separate problems because of 2 distinct ICFR signatures

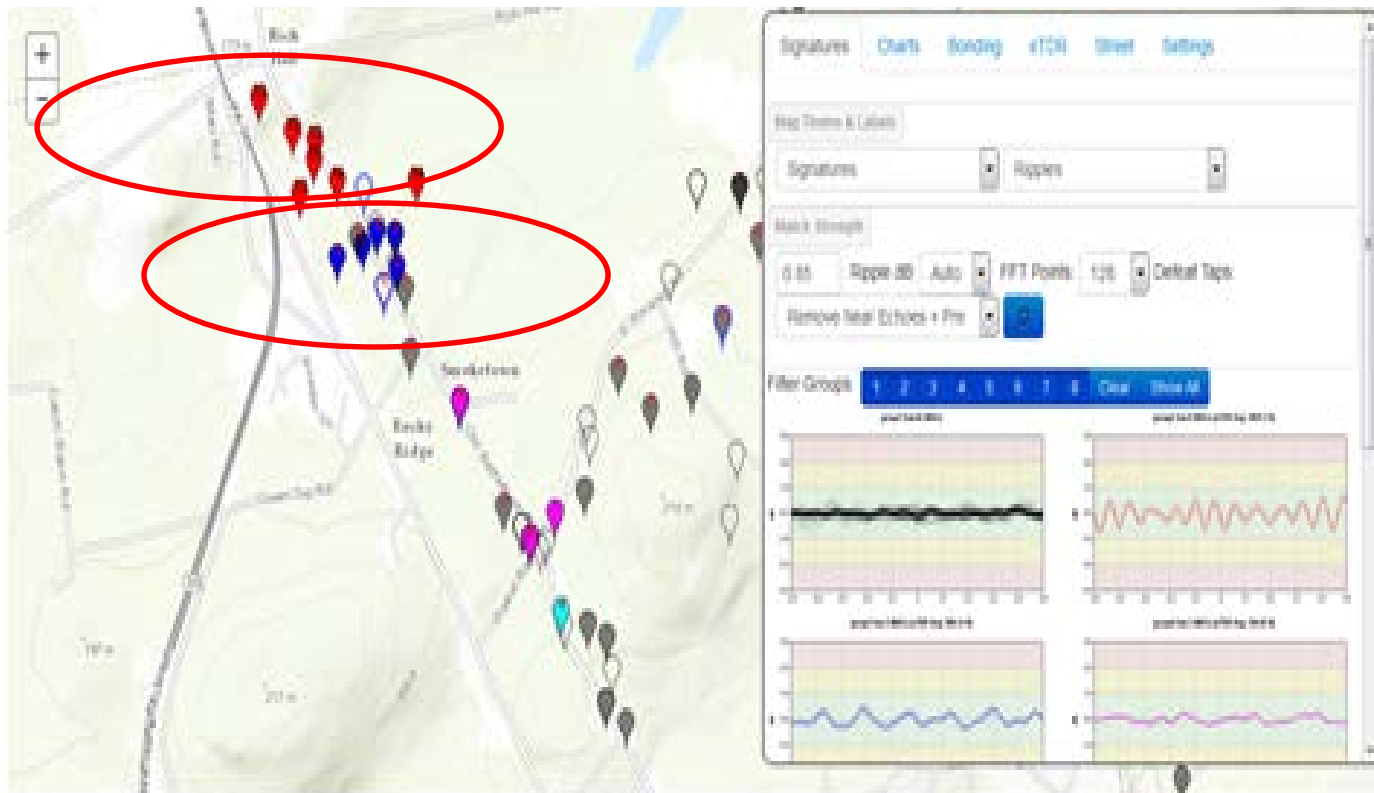

Example 4 Step 2 System Map Analysis

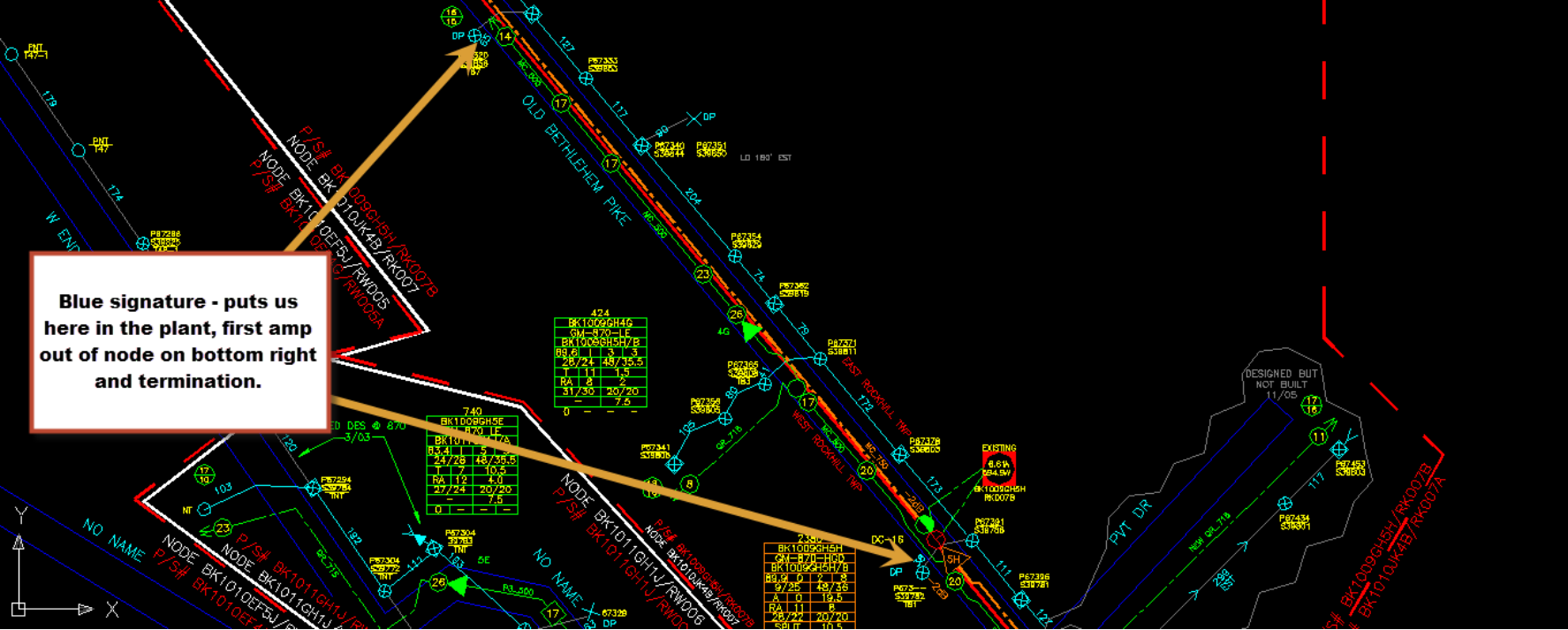

Example 4 Step 3 EQ analysis with meter

- PNM and meter shows an issue at $\approx 320'$
- Notice higher channel used this time

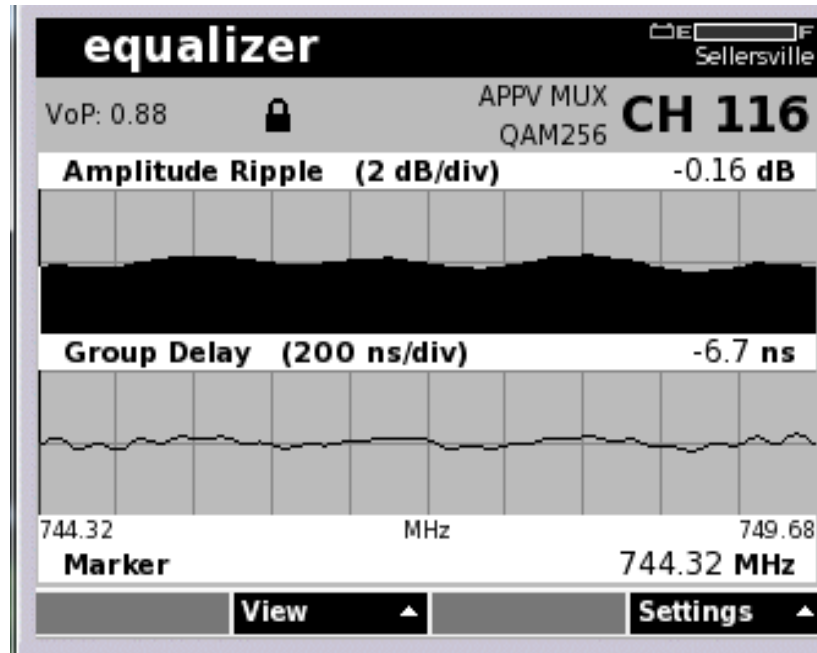
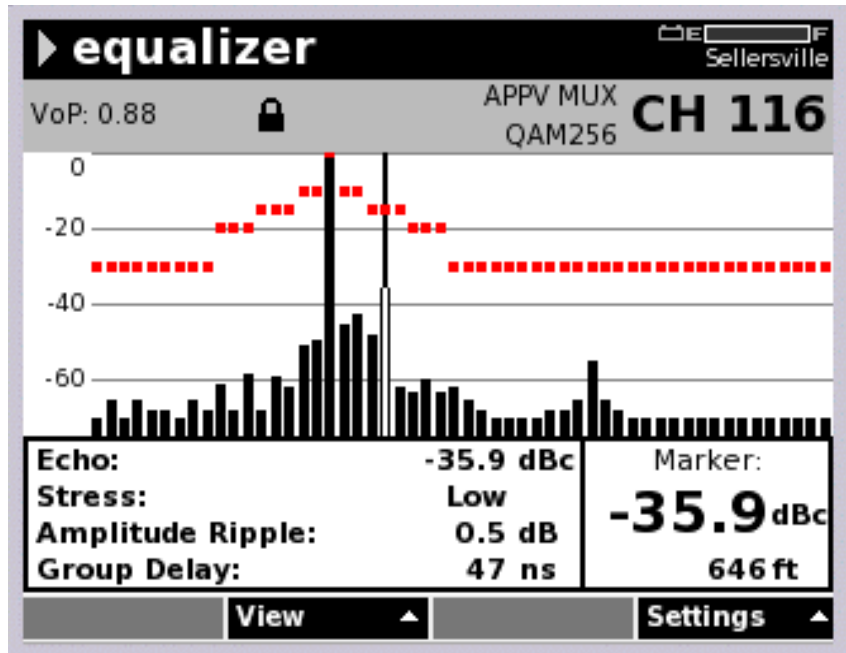

Example 4 Step 6 Repair the fault

- Repaired tap with bad shorting bar 320 ' away



Example 4 Step 7 Verification

- In this example, the blue problem from the initial map is repaired.
- Problem with the red ICFR signature still exists, but on a different leg of the amplifier.
- Back to Step 2 after analysis

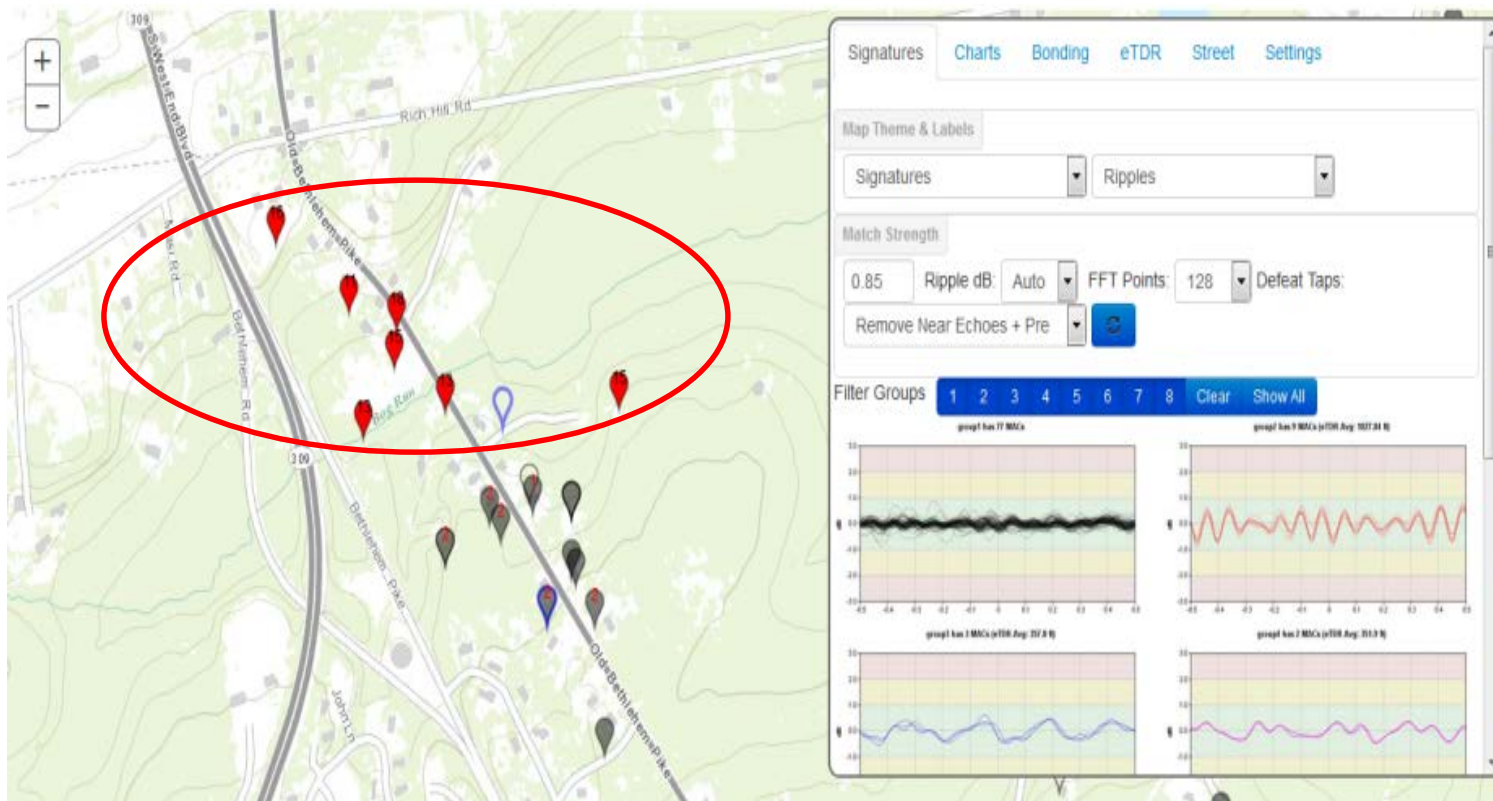

Example 4 Step 2 System Map Analysis

- Second analysis shows a second issue from another feeder leg.

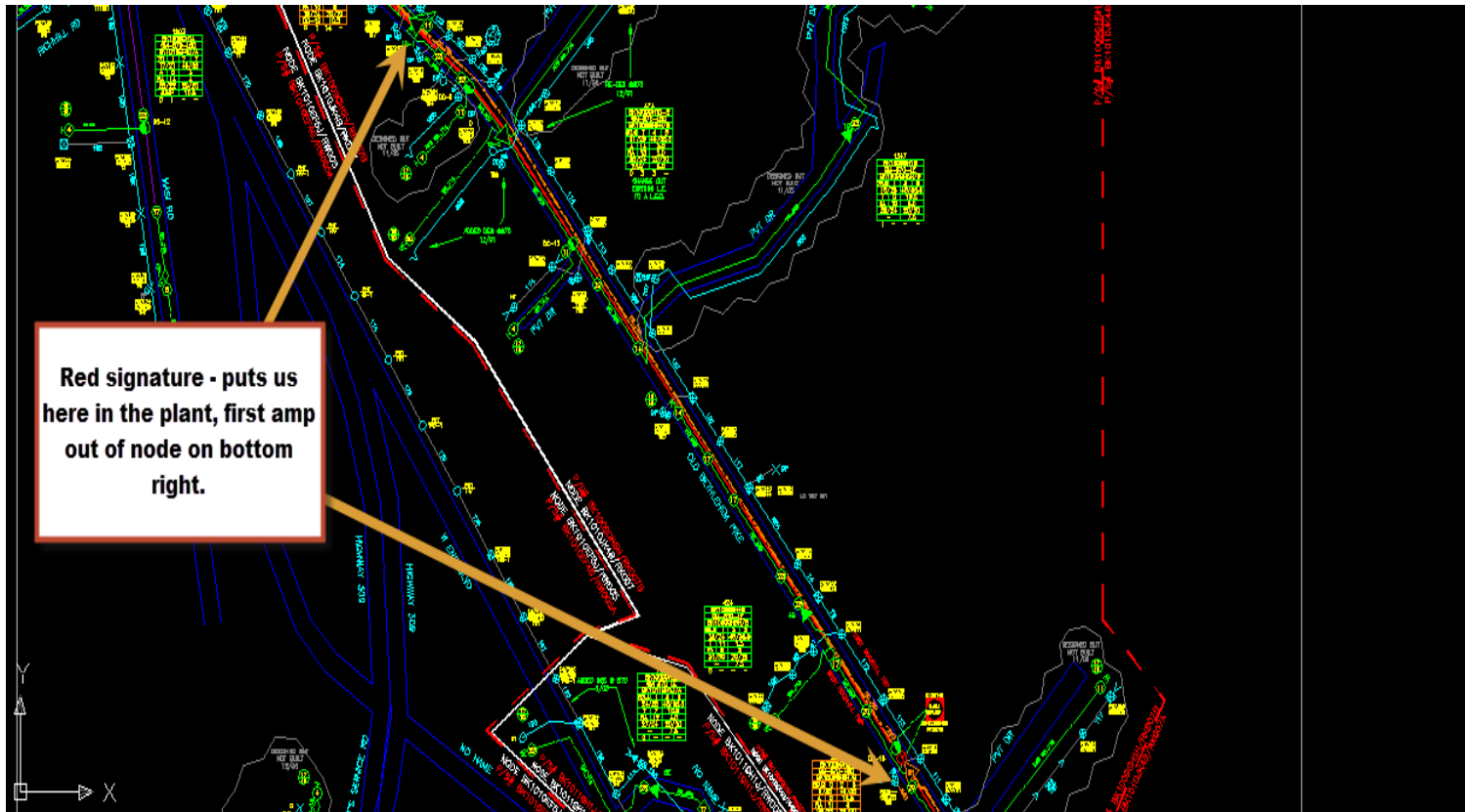

Example 4 Step 3 EQ analysis before

- Shows issue at 1050'

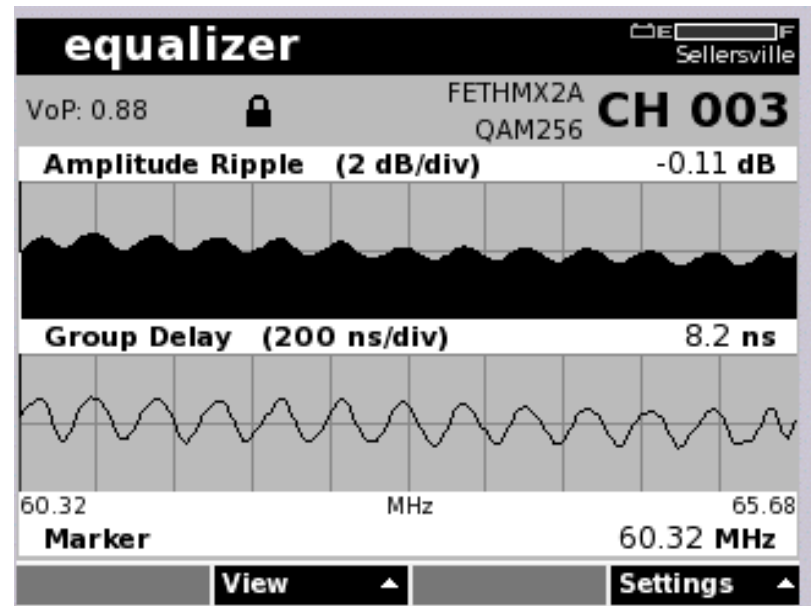
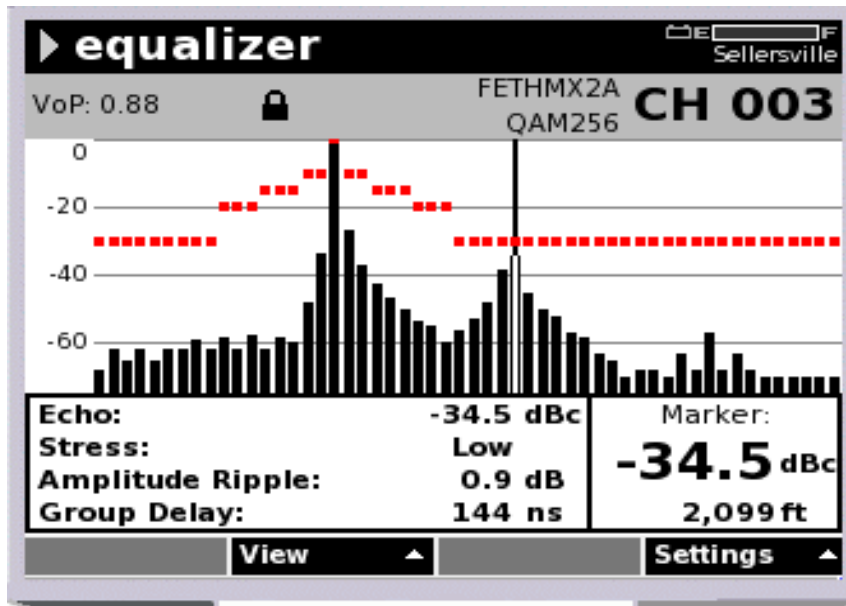

Example 4 Step 6 Repair the problem

- Burned cable from downed power lines.



Example 4 Step 7 verification using EQ

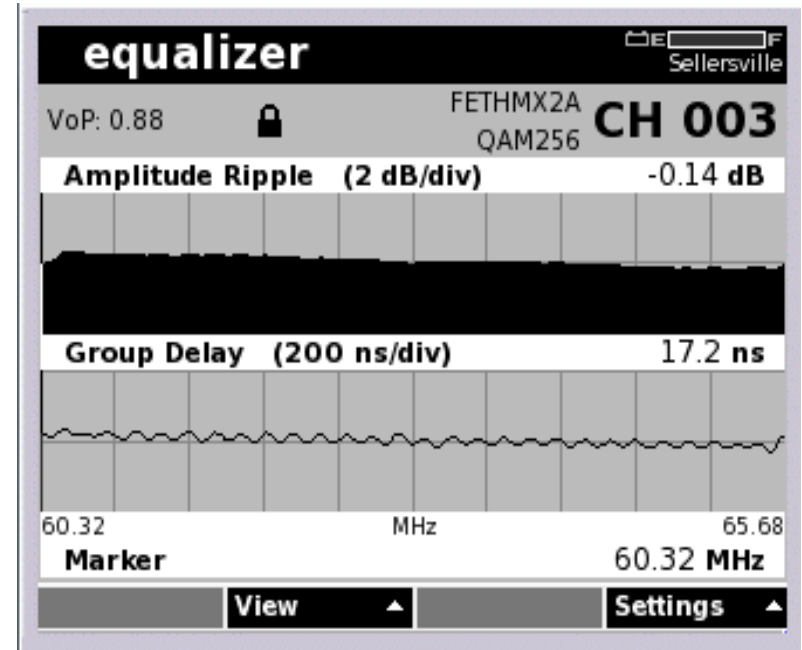
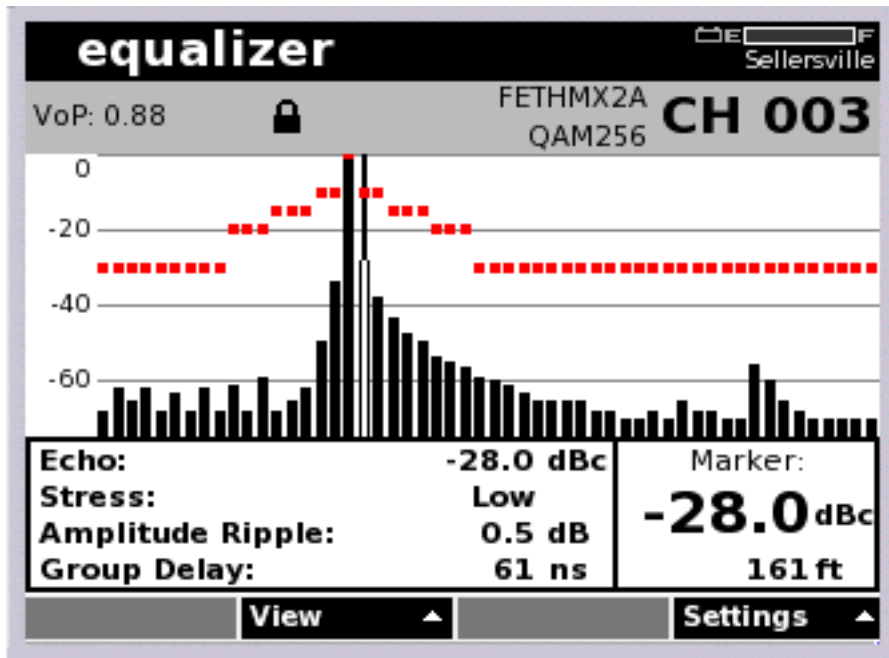

Example 4 Step 7

Verification

- PNM now shows both problems now cleared

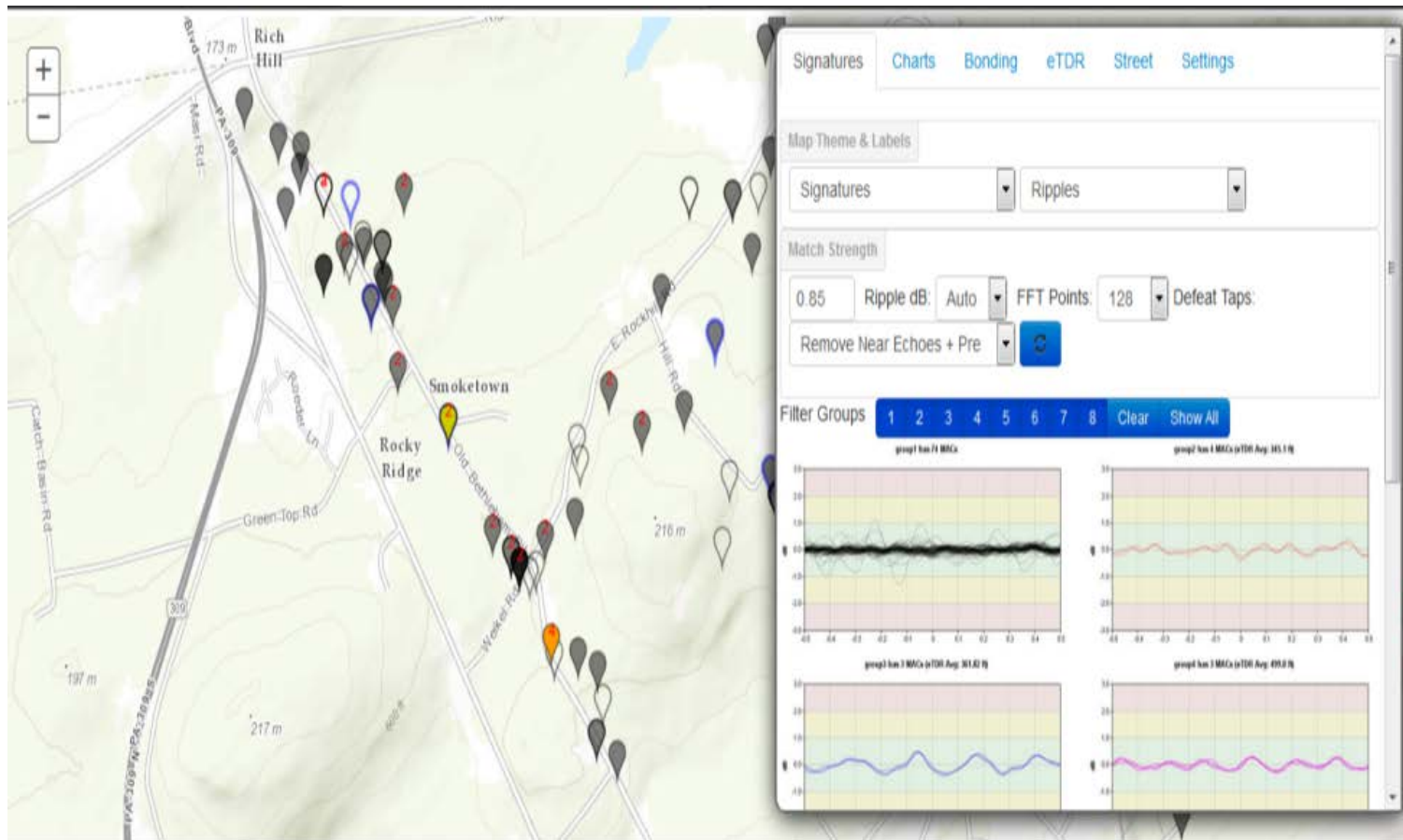

Summary

- Adaptive Equalizers are comprised of taps that are time based. Because the time period of each tap is known and the speed of the signals, the distance to a fault can be calculated from the current location. The AE is at the input to a digital receiver.
- Pre Eqs are at the output of the CM upstream transmitter. The coefficients of the Pre EQ taps compensate for upstream linear impairments and elevated taps represent the distance to an upstream reflection point.
- Analysis of the results of a PNM tool and a modern meter equipped with an AE is helpful diagnosing the location of a PNM event. Save both time and system maintenance outages.

References

- “RF Impairments in the Return Path and their impact on DOCSIS performance”, by Jack Moran, Motorola
- National Cable Television Association’s Recommended Practices for Measurements on Cable Television Systems, 2nd Edition, October 1997 “Supplement on Upstream Transport Issues.”
- “Modern Cable Television Technology”, by Walter Cicora, James Farmer and David Large
- Return Path Familiarization and Node Return Laser Setup,” by Frank Eichenlaub, Cisco Systems
- Characterizing and Aligning the HFC return path for Successful DOCSIS 3.0 Rollouts, Dr. Robert L. Howald et al, Motorola, SCTE Cable Tech Expo 2009
- Using Edgehealth Pre-equalization analysis tool, Presentation by Cox Communications
- Impulse Response Echo Distancing, Presentation by Larry Wolcott and Phil Chang, Comcast
- Using the DSAM Equalizer Function, Mike Fenton, Comcast
- Similarities of Wave Behavior, Bell Labs, Dr. John Shive, 1959

Thank You, Questions?



Extra Slides